

SINGLE FAMILY

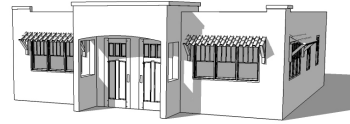

ACCESSORY UNITS



ATTACHED HOUSE



TOWNHOUSE



APARTMENTS

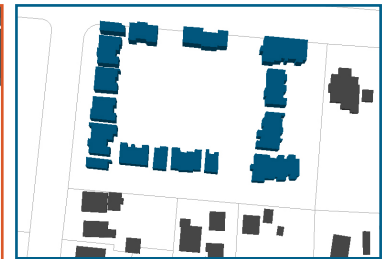
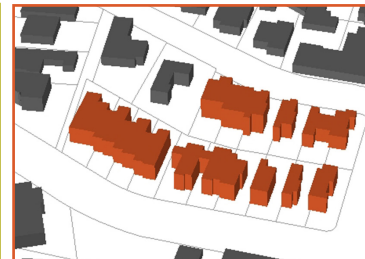
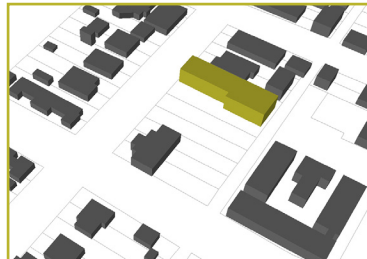
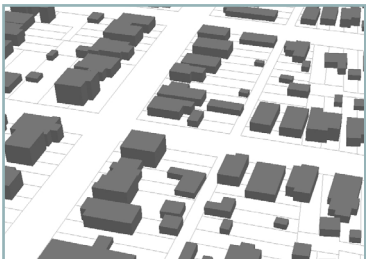
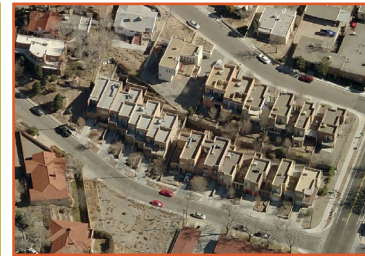

VISUALIZING DENSITY: ALBUQUERQUE'S HOUSING TYPES & DENSITIES



CITY OF ALBUQUERQUE PLANNING DEPARTMENT, MAY 2015

ACCORDING TO THE MID REGIONAL COUNCIL OF GOVERNMENTS THE ALBUQUERQUE METROPOLITAN REGION WILL EXPERIENCE SIGNIFICANT GROWTH BY 2040 - INCREASING BY MORE THAN 50 % TO 435,000 RESIDENTS.

As Albuquerque continues to grow, the City struggles to balance the demand for new and rehabilitated housing with the need for managed growth on its urban fringe. One practical way to address the demand for new housing while controlling the rate of the City's geographic expansion is to encourage higher residential densities.

Residential density refers to the amount of residential development on a parcel of land - the greater the number of units per acre, the higher the density, the fewer units, the lower the density. While higher residential densities are often faced with opposition, adding residential density in appropriate locations can generate community, economic, and fiscal benefits while generally creating great places to live.

BENEFITS OF DENSITY INCLUDE:

THE PROTECTION OF THE ENVIRONMENT

By concentrating development and people within a smaller geographic area higher densities reduce land consumption, allow for the protection of valuable and/or sensitive areas, and generally reduce the impact of the built area on the environment.

REDUCED INFRASTRUCTURE COST

Adding population to existing infrastructure service areas creates an economy of scale that translates into lower installation and operational costs.

RESOURCES & POLLUTION REDUCTIONS

Compact, dense developments use fewer energy resources and generate less pollution than suburban ones.

THE EXPANSION TRANSPORTATION CHOICES

Concentrated development provides transportation choices while simultaneously providing the populations needed to support ridership for the transit system.

VARIETY OF HOUSING CHOICE & AFFORDABILITY

Denser development patterns offer a greater range of housing options - vary in style, size, and cost - which in turn accommodate a broader range of lifestyles choices.

ACCESS TO DIVERSE SERVICES/AMENITIES

Density generates diverse and specialized services and amenities that cannot be achieved in sparse, suburban developments.

IMPROVED SAFETY

Density has the potential to increase social interaction, visibility, and surveillance which can consequently deter crime.

Evolving demographics and generational preferences are generating an extensive shift in housing demand. Albuquerque's patterns of housing development and new housing stock will need to adapt in order to keep up with these evolving preferences.

DEMOGRAPHIC SHIFTS

More than **80%** of growth will be a **New Demographic Majority**.

About the equivalent of **40%** of Albuquerque's growth will be **65+**

More than **80%** of household growth will be **without children**.

More than **40%** of household growth will be **single persons**.¹

Housing preferences held by specific generational cohorts —the Baby Boomers (ages 51-70) and Millennials (ages 18-34) — are driving change in housing markets due to their profound distribution.

The baby boomer generation, those born between 1946 and 1964, currently totals 77 million or 25%, of the total U.S. population. 10,000 boomers will turn 65 everyday from 2011 through 2029, and as they age their housing demands and choices are changing. ²

GENERATIONAL PREFERENCES OF BABY BOOMERS:

- An increased interest in downsizing. Boomers are opting towards condos and smaller, lower maintenance homes in order to have more time to pursue their own interests.
- An increased interest in renting over buying.
- An increased preference for amenities; particularly, walkable neighborhoods in proximity to shopping, grocery and drug stores, and to bus and bike systems. ³

21% of Baby Boomers expect to have adult children living at home.

19% of single boomers expect to have their parents or grandparents in residence. ⁴

Millennials, those individuals born between 1981 and 1999, are currently the largest generation within the United States -at 85 million or 28 percent of the total population. The choices made by Millennials will therefore have a profound impact on the U.S. housing market for decades ahead.

GENERATIONAL PREFERENCES OF MILLENNIALS:

- An increased preference in living at home with their parents and waiting to rent or purchase a home.
- An increased preference in renting over buying.
- An increased preference for living in urban areas.
- A willingness to live in smaller units and trade in-home amenities for location.
- A preference for neighborhoods that are close to a mix of shops, restaurants and offices.
- A preference in access to high quality, public transportation systems. ⁶

These trends demonstrate an extensive shift in housing demand away from large, single-family suburban homes toward smaller, urban units. Last year, the Pew Research Center found that 48 percent of Americans overall choose walkable, urban neighborhoods over sprawling suburban ones. In light of these changes, Albuquerque is facing a major problem- our current housing stock doesn't support such preferences.

MORE THAN HALF OF AMERICANS PREFER NEIGHBORHOODS THAT ARE CLOSE TO SHOPS, HAVE A MIX OF INCOMES, AND HAVE PUBLIC TRANSPORTATION.

The City has a huge unmet demand of housing stock for residents that seek urban, walkable lifestyles. In order to meet the projected demands, Albuquerque's housing stock must be supplied with newly preferred units including apartments, townhouses, condos, and small lot (less than 1/6acre) houses.

This document chronicles the variety of Albuquerque's current housing stock placing particular focus on the residential densities and types that could begin to meet these new housing preferences.

The housing types and densities depicted in this document are as follows:

Housing Type	Pages
SINGLE-FAMILY HOUSING	8-9
SECONDARY LIVING QUARTERS	10-11
ATTACHED HOUSES	12-13
TOWNHOMES	13-14
APARTMENTS	15-16
LIVE/WORK UNITS	17-18
MIXED-USE HOUSING	19-20

The map on page 7 identifies the location of the housing units illustrated in this report.

HOUSING TYPES

Housing can be built in a large variety of configurations. The basic division of types occurs between free-standing, single-family houses and attached, multi-user dwellings.

HOUSING DENSITY

Housing density or residential density refers to the number of homes per unit of land. Residential densities are calculated using a basic ratio formula: the number of dwellings divided by the area of land they occupy, and are therefore reported in dwelling units per acre (or du/ac).

$$\text{GROSS DENSITY} = \frac{\text{TOTAL RESIDENTIAL UNITS}}{\text{TOTAL DEVELOPMENT LAND AREA}}$$

$$\frac{6}{1} \text{ -OR- } 6 \text{ DU/A}$$

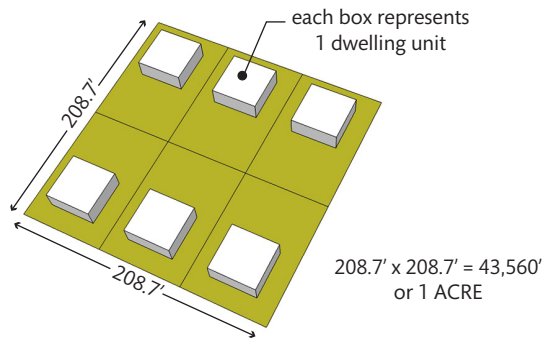

SINGLE- FAMILY HOUSE

A single family dwelling refers to a dwelling (house) on a property designed to be occupied by only one family.

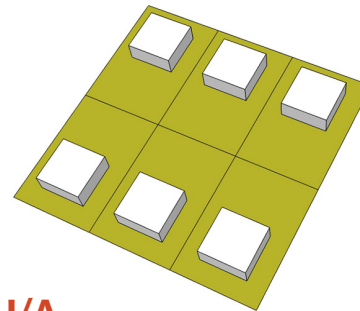

ACCESSORY LIVING QUARTERS

Living quarters containing a kitchen, within an accessory building, typically limited to smaller than the main building.

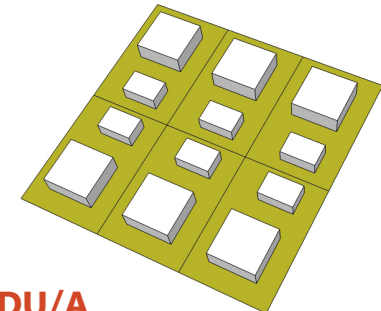

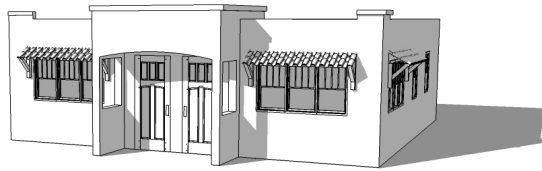

ATTACHED HOUSE

A house divided into several dwelling units, with a separate entrance for each apartment.

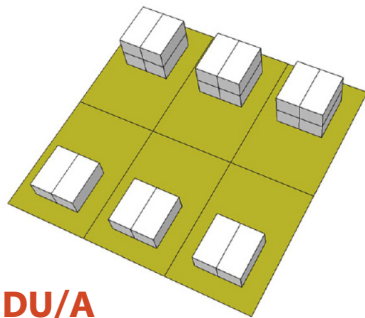

18 DU/A

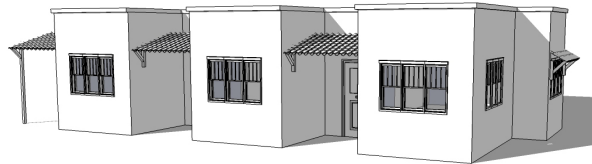

TOWNHOUSE

One of a group of two to eight attached dwelling units divided from each other by common walls, each having a separate entrance leading directly to the outdoors at ground level.

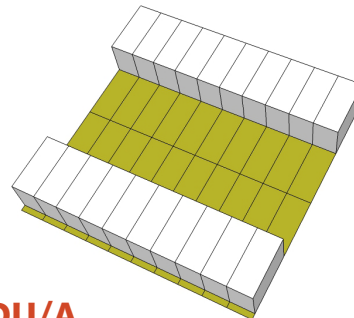

20 DU/A



APARTMENTS

Structures containing two or more dwelling units each, including dwelling units which do not have a separate entrance leading directly to the outdoors at ground level.

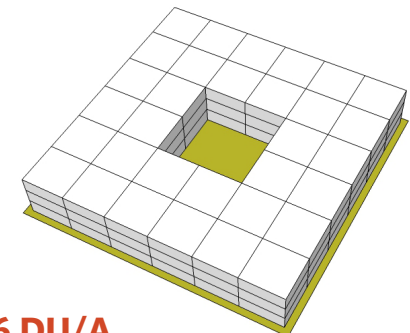

96 DU/A

CHANGING PREFERENCES

While typically not considered housing types, Live/Work & Mixed-Use developments are being shown within this document because they meet the urban, walkable type of developments desired under the new housing / lifestyle preferences.



LIVE/WORK UNITS

A live/work unit is defined as a single unit (e.g., studio, loft, or one bedroom) consisting of both a commercial/office and a residential component that is occupied by the same resident. The live/work unit shall be the primary dwelling of the occupant.

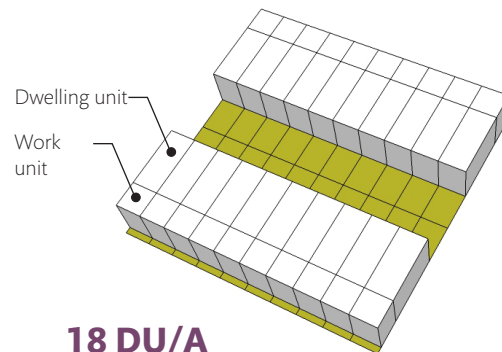

18 DU/A



MIXED USE

A building that contains at least one floor devoted to allowed nonresidential uses and at least one devoted to allowed residential uses

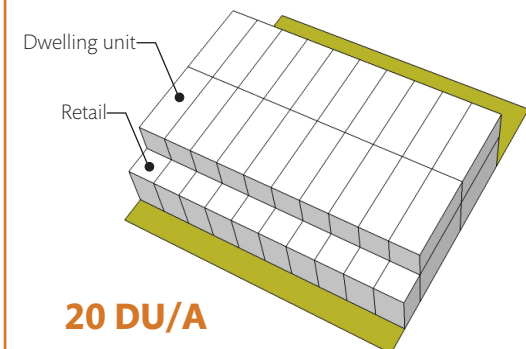

20 DU/A

HOUSING LOCATIONS

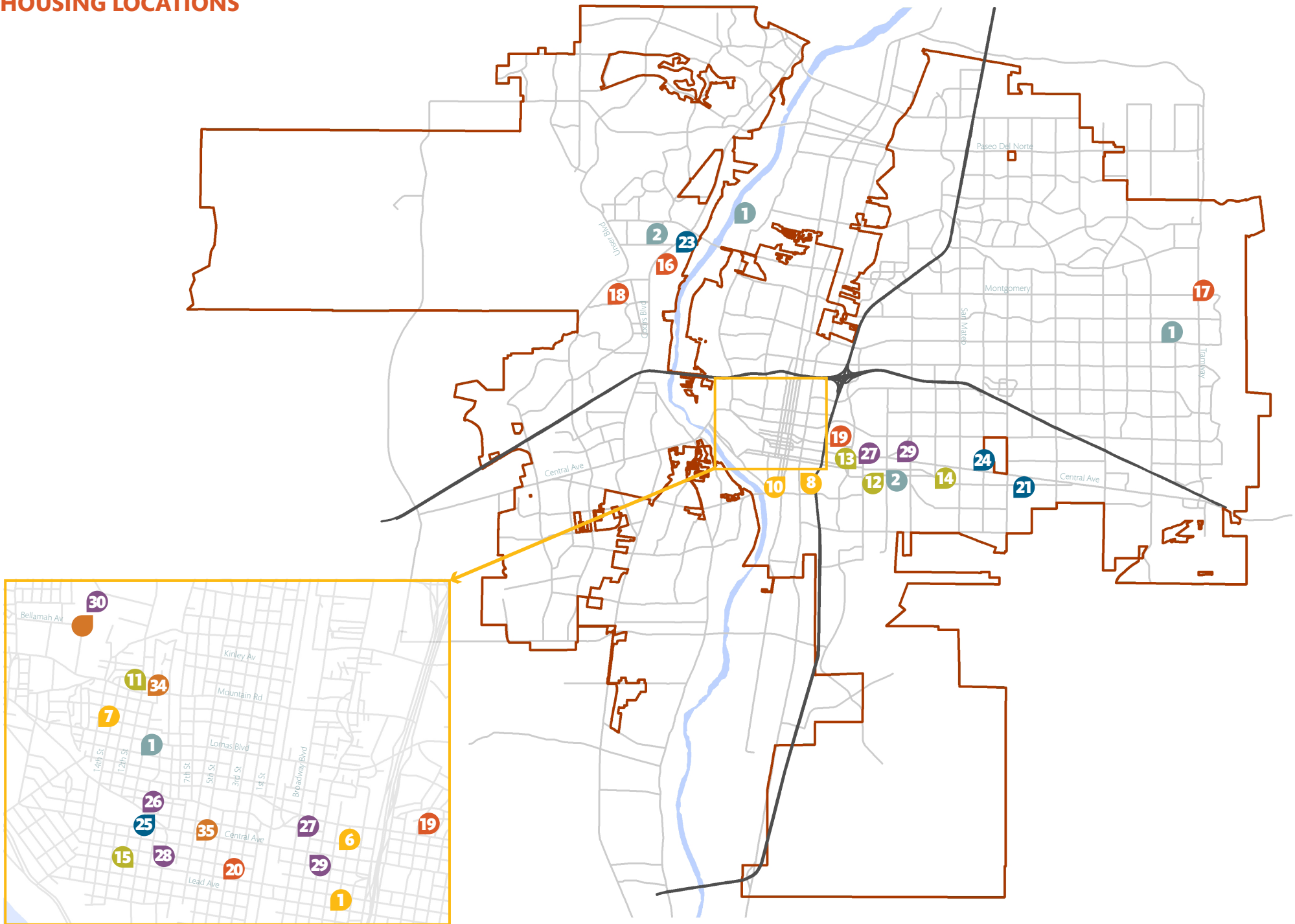

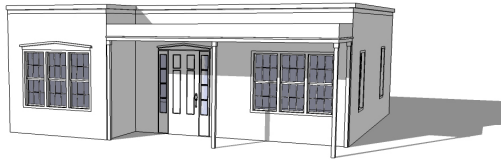

SINGLE-FAMILY HOUSING

A single family dwelling refers to a dwelling (house) on a property designed to be occupied by only one family.



LOS RANCHOS Address:
Site Area: 55 Acres
Number of Units: 13
Gross Density: .24 Acre
Built: N/A

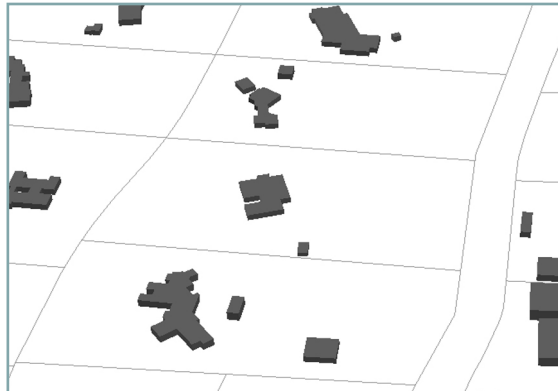

TAYLOR RANCH Address:
Site Area: 6 Acres
Number of Units: 23
Gross Density: 3.8/Acre
Built: N/A

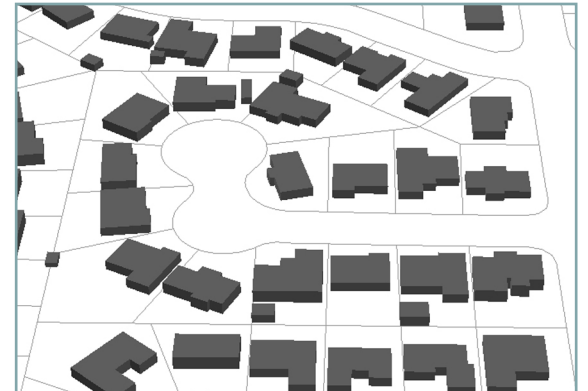



UNIVERSITY HEIGHTS

Address:
Site Area: 8 Acres
Number of Units: 35
Gross Density: 4.38/Acre
Built: 1950s

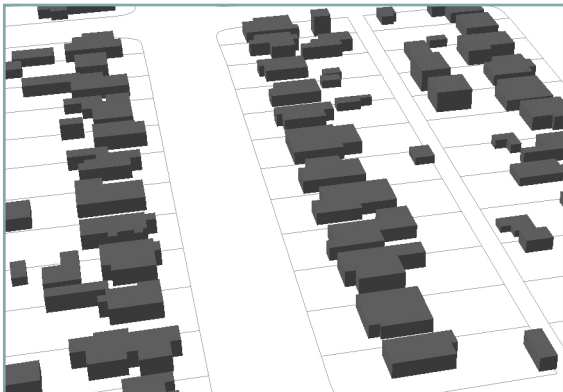

EMBUDO CANYON

Address:
Site Area: 9 Acres
Number of Units: 40
Gross Density: 4.4/Acre
Built:



DOWNTOWN NEIGHBORHOODS

Address:
Site Area: 8 Acres
Number of Units: 36
Gross Density: 4.5/Acre
Built: 1920s

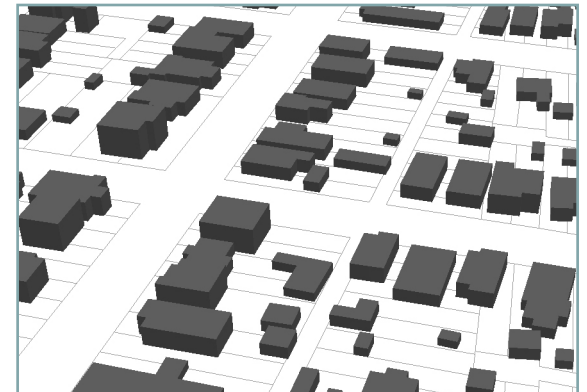

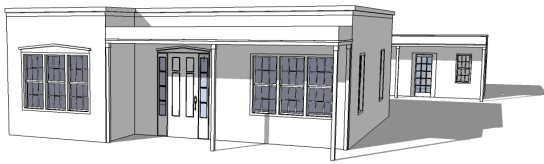

ACCESSORY LIVING QUARTERS

Living quarters containing a kitchen, within an accessory building, typically limited to smaller than the main building.



121 HIGH ST NE

Address: 121 High St NE
Site Area: .3214 Acres
Number of Units: 2
Gross Density: 6.22/Acre
Built: N/A

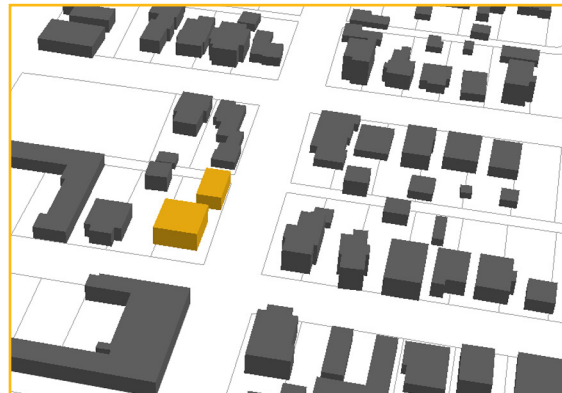
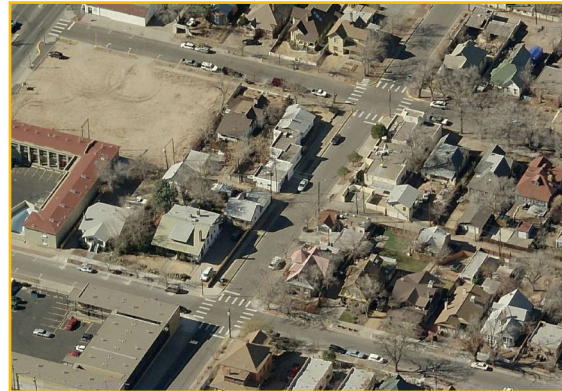

512 15TH ST NW

Address: 511 15th St
Site Area: .1664 Acres
Number of Units: 2
Gross Density: 12.02/Acre
Built: N/A

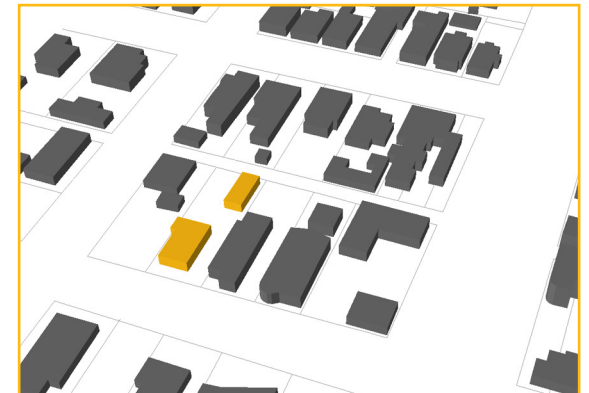



818 EDITH BLVD SE

Address: 818 Edith Blvd
Site Area: .1125 acres
Number of Units: 2
Gross Density: 17.78/Acre
Built: N/A



423 HIGH ST SE

Address: 423 High St SE
Site Area: .1125 Acres
Number of Units: 2
Gross Density: 17.78/Acre
Built: N/A

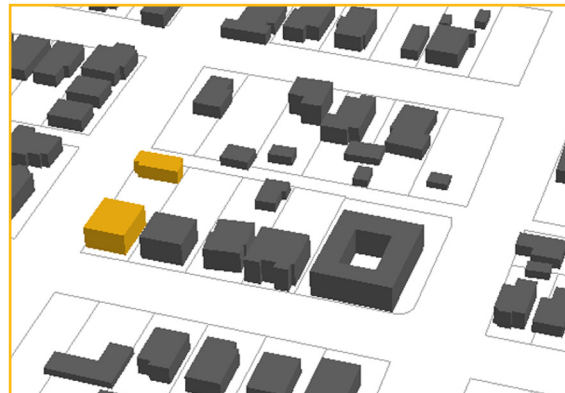

1124 3RD ST SW

Address: 1124 3rd St SW
Site Area: .0588 Acres
Number of Units: 2
Gross Density: 34.01/Acre
Built: N/A



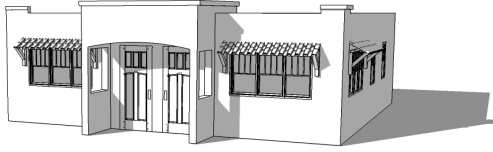

ATTACHED HOUSE

A house divided into several dwelling units, with a separate entrance for each apartment.



1025 MOUNTAIN RD NW

Address: 1025 Mountain Rd
Site Area: 0.3282 Acres
Number of Units: 5
Gross Density: 15.23/Acre
Built: N/A

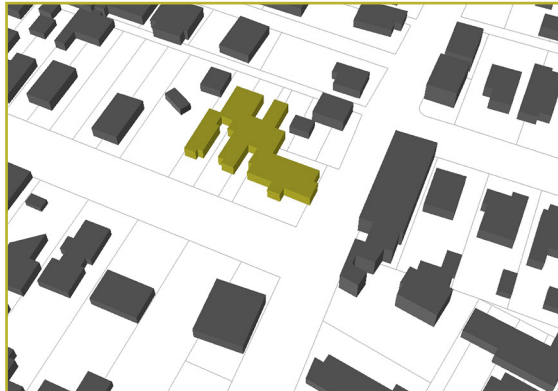

501 MADISON PL SE

Address: 501 Madison Pl
Site Area: 0.264 Acres
Number of Units: 2
Gross Density: 7.6/Acre
Built: 2013?

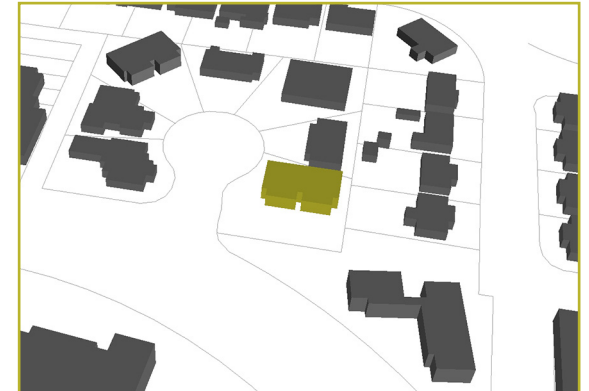



323 TERRACE ST SE

Address: 702 Broadway SE
Site Area: 0.2984 Acres
Number of Units: 4
Gross Density: 13.4/Acre
Built: N/A

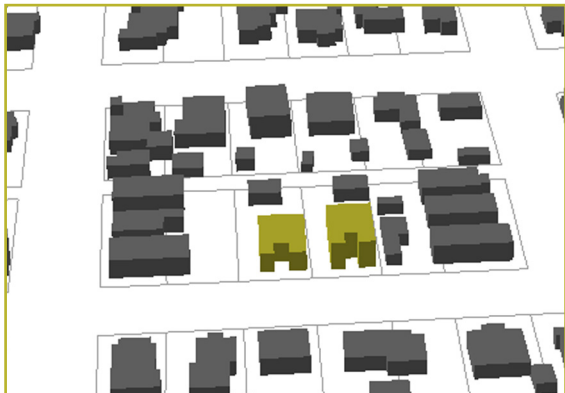

VASSAR & COAL AVE TRIPLEX

Address: 324 Vassar Dr SE
Site Area: .0163 Acres
Number of Units: 3
Gross Density: 18.4/Acre
Built: 2014



1010 LEAD AVE

Address: 1010 Lead Ave SW
Site Area: 0.32 acres
Number of Units: 5
Gross Density: 15.6/Acre
Built: 2014

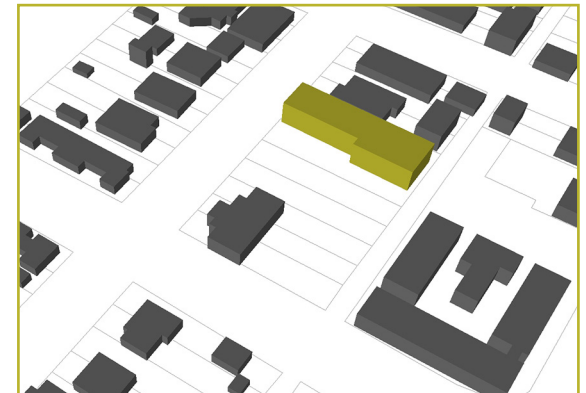

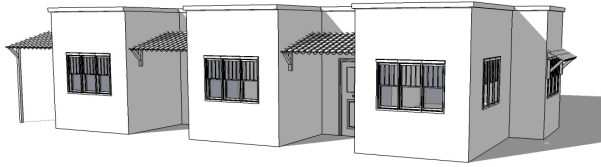

TOWNHOUSE

One of a group of two to eight attached dwelling units divided from each other by common walls, each having a separate entrance leading directly to the outdoors at ground level.



ANDALUCIA TOWNHOUSES

Address: Sevilla Ave NW
Site Area: 8 Acres
Number of Units: 41
Gross Density: 5.3/Acre
Built: 2014

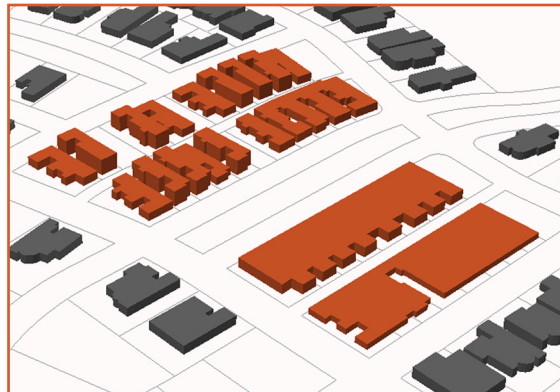

GLENWOOD LOFTS

Address: 4312 Prairie Loft Way
Site Area: 2.05 Acres
Number of Units: 21
Gross Density: 10.23/Acre

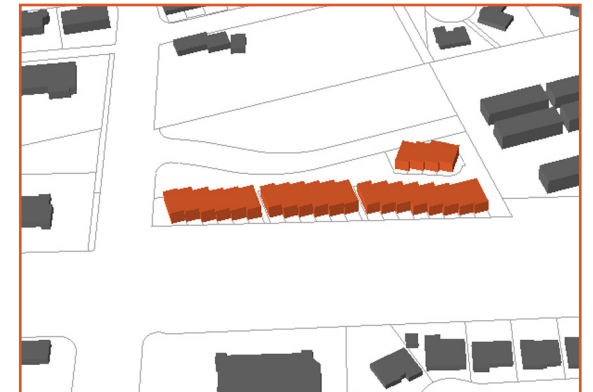



18

SAN BLAS PLACE TOWNHOUSES

Address: San Blas Pl SW
Site Area: 4.04 Acres
Number of Units: 43
Gross Density: 10.5/Acre
Built: N/A

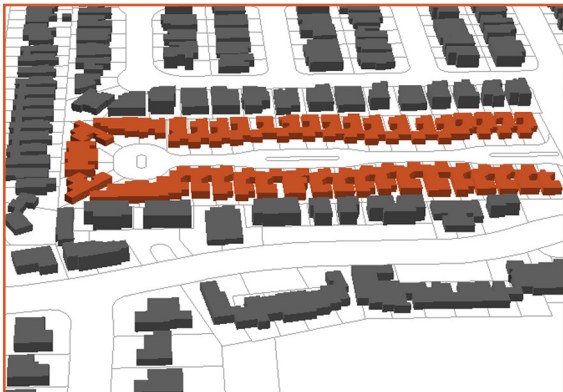

19

MARTIN LUTHER KING TOWNHOUSES

Address: 401 Ridge Pl NE
Site Area: 1.13 Acres
Number of Units: 16
Gross Density: 14.1/Acre
Built: N/A

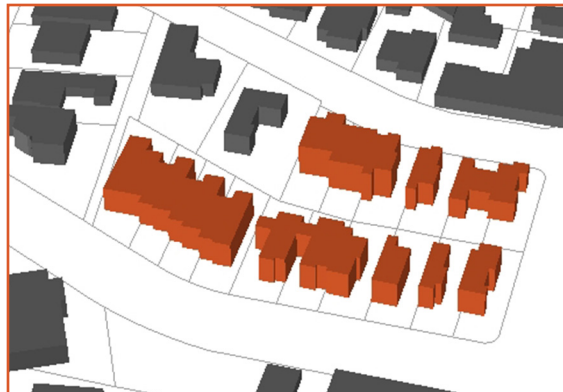

20

ELEMENTS TOWNHOUSES

Address: 372 3rd St SW
Site Area: .141 acres
Number of Units: 7
Gross Density: 50/Acre
Built: 2013

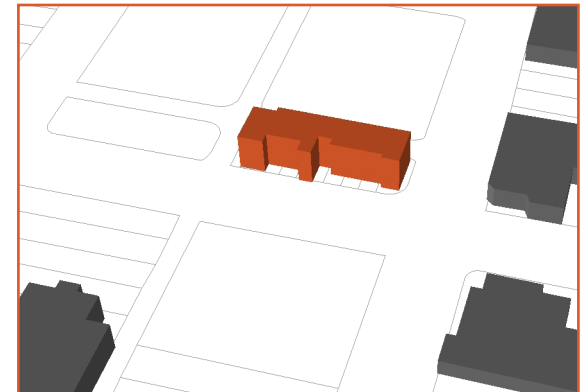
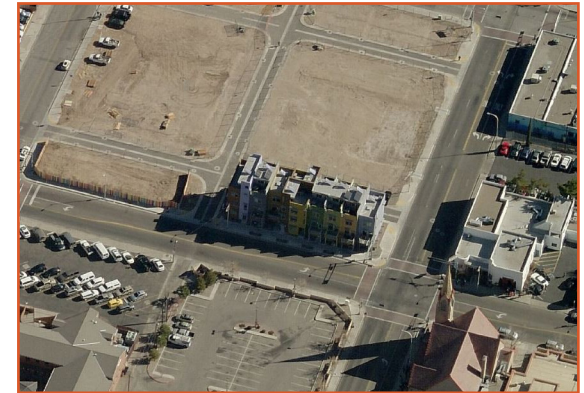



APARTMENTS

Structures containing two or more dwelling units each, including dwelling units which do not have a separate entrance leading directly to the outdoors at ground level.



ANDALUCIA VILLAS

Address: 702 Broadway SE
Site Area: 15.86 Acres
Number of Units: 240
Gross Density: 15.13/Acre
Built: 2014

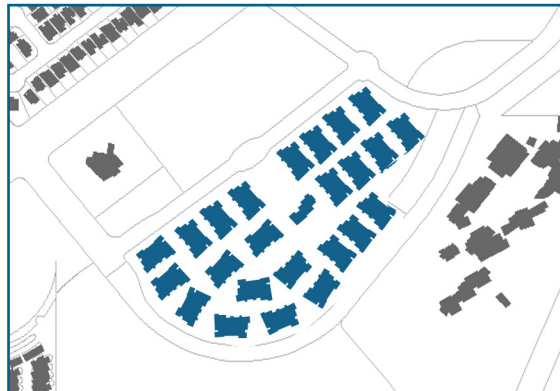

PLAZA FELIZ

Address: 517 San Pablo St SE
Site Area: 3.60 Acres
Number of Units: 66
Gross Density: 18.3/Acre
Built: 2014

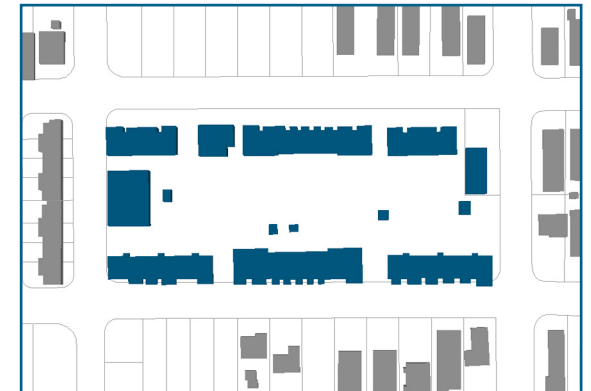



**PLAZA
CIUDANA**

Address: 310 Indian School Rd NE
Site Area: 2.99 Acres
Number of Units: 74
Gross Density: 24.71/Acre
Built: 2014

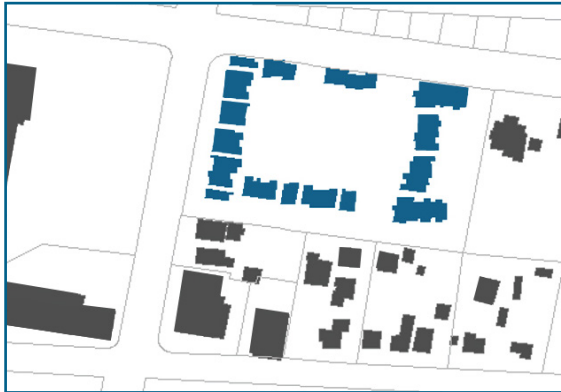

SUNDOWNER

Address: 6101 Central Ave
Site Area: 2.36 Acres
Number of Units: 71
Gross Density: 30.12/Acre
Built: renovated 2014

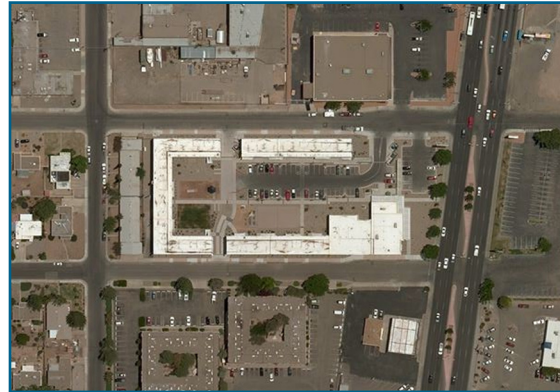

**SILVER MOON
LODGE**

Address: 918 Central Ave
Site Area: 1.38 Acres
Number of Units: 151
Gross Density: 109.5/Acre
Built: 2014



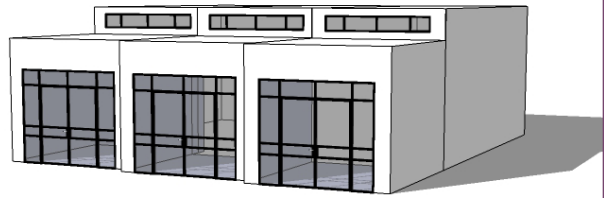

LIVE / WORK UNITS

A live/work unit is defined as a single unit (e.g., studio, loft, or one bedroom) consisting of both a commercial/office and a residential component that is occupied by the same resident. The live/work unit shall be the primary dwelling of the occupant.



10TH ST & COPPER AVE

Address: 1919 Copper Ave
Site Area: 0.24 Acres
Number of Units: 3
Gross Density: 12.45/Acre
Built: ?

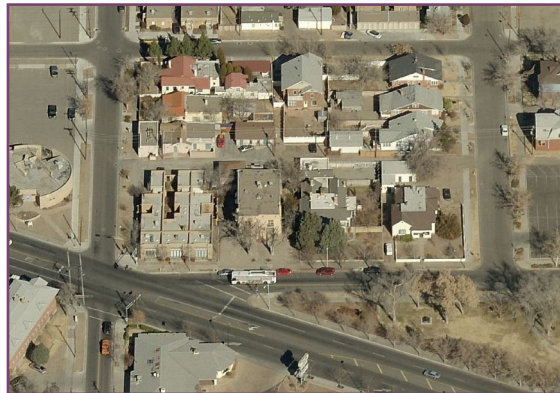

BELVERDE

Address: 301 Arno St SE
Site Area: 1.77 Acres
Number of Units: 54
Gross Density: 30.45 /Acre
Built: 2008

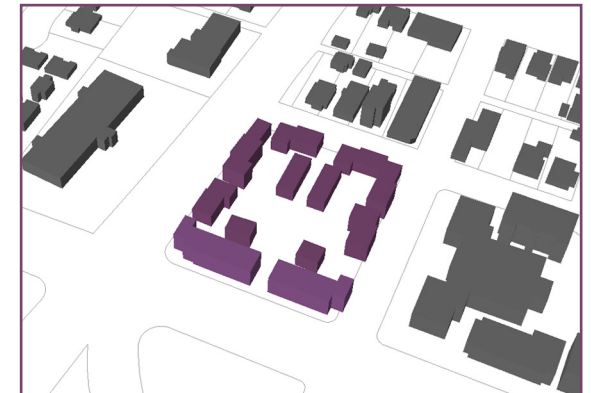



SILVER LOFTS Address: 702 Broadway SE
 Site Area: 0.97 Acres
 Number of Units: 47
 Gross Density: 48.68/Acre
 Built: ?

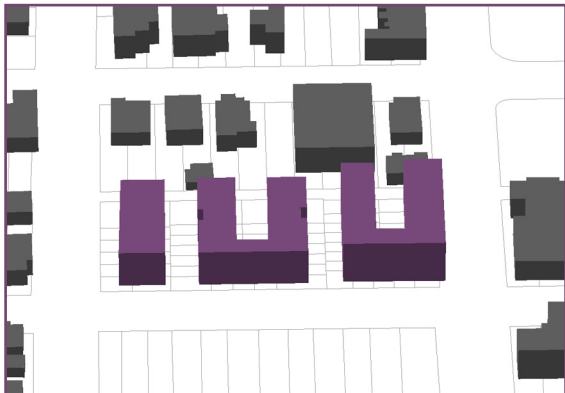

400 CENTRAL SE Address: 400 Central Ave
 Site Area: 0.31Acre
 Number of Units: 18
 Gross Density: 58.77/Acre
 Built: 2004

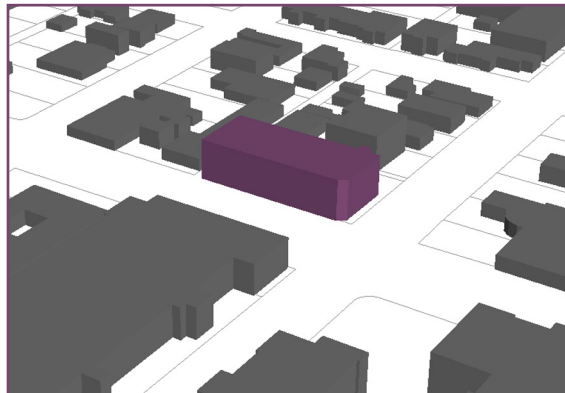
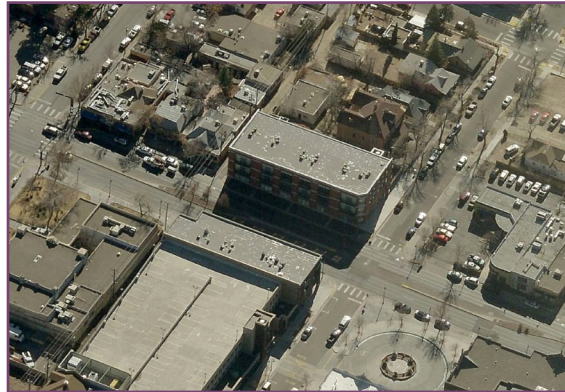

ARTISAN VILLAGE Address: 918 Central Ave
 Site Area: 1.38 Acres
 Number of Units: 151
 Gross Density: 109.4/Acre
 Built: 2014





MIXED USE

A building that contains at least one floor devoted to allowed nonresidential uses and at least one devoted to allowed residential uses

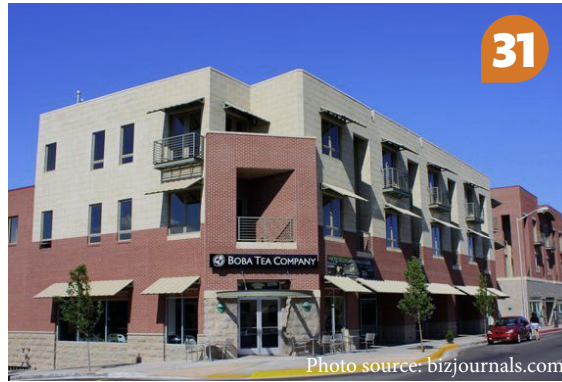

THE PLACE IN NOB HILL

Address: 6101 Central Ave
Site Area: 0.85 Acres
Number of Units: 26
Gross Density: 30.65/ Acre
Built: 2005

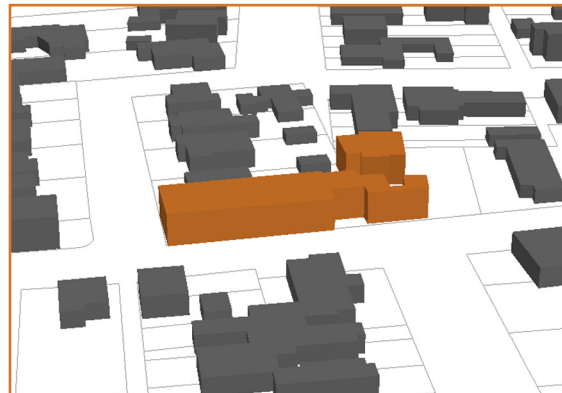

BRICKLIGHT

Address: 105 Harvard Dr. SE
Site Area: 0.79 Acres
Number of Units: 46
Gross Density: 58.08 /Acre
Built: 2003

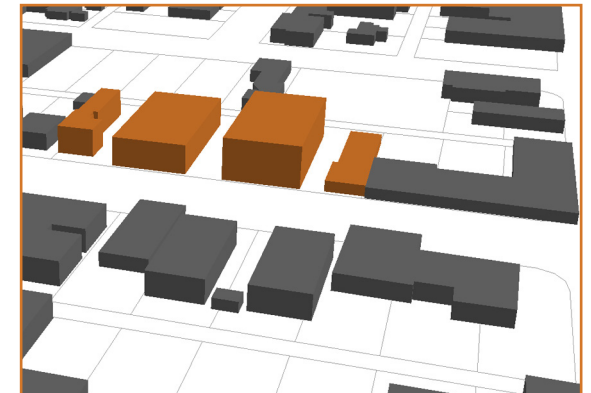
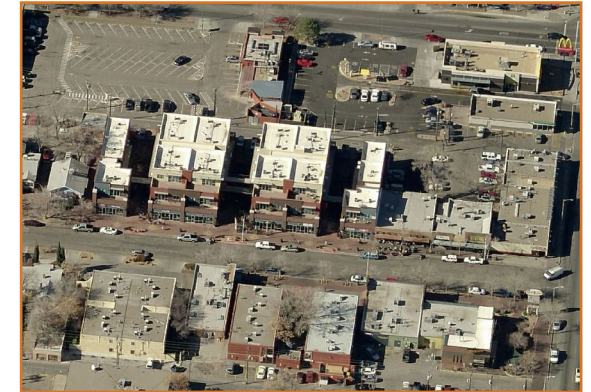



**THE ARTISAN
IN SAWMILL**

Address: 400 Central Ave
Site Area: 0.31Acre
Number of Units: 18
Gross Density: 58.77/Acre
Built: 20o4



**URBAN
MOUNTAIN**

Address: 1102 Mountain NW
Site Area: 0.33 Acres
Number of Units: 45
Gross Density: 134.93/Acre
Built: 2011

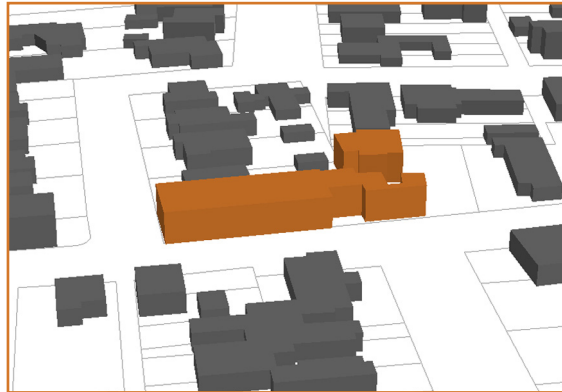
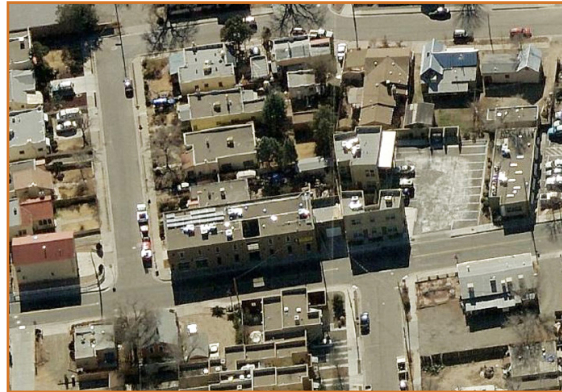

ANASAZI

Address: 524 Central Ave SW
Site Area: 0.24 Acres
Number of Units: 45
Gross Density: 186.72/Acre
Built: 2000 - 2014

