

CHAPTER 7: DESIGN MANUAL

Contents

CHAPTER 7: DESIGN MANUAL	<u>171130</u>
A. GUIDING DOCUMENTS	<u>171130</u>
B. ON-STREET FACILITIES.....	<u>175133</u>
C. TRAIL DESIGN	<u>206163</u>
D. GENERAL INTERSECTION DESIGN GUIDELINES.....	<u>264209</u>
E. WAYFINDING	<u>277222</u>
F. MAINTENANCE & OPERATIONS.....	<u>284229</u>

A. Guiding Documents

The City of Albuquerque has been working to implement on- and off-street projects to encourage walking and cycling, ~~to improve safety~~ ~~the user experience,~~ ~~and to improve~~ accessibility, and ~~to~~ enhance the quality of the walkway and bikeway networks so that these activities become integral parts of daily life. While Albuquerque is growing, it has a predominantly built urban environment, and many future projects will involve retrofitting existing streets and intersections. The City has a moderate demand for on-street parking, an auto-oriented roadway system reliant on high-capacity arterials and many other complex situations. When looking to implement sidewalks and bike lanes or other improvements on City streets, most standard design manuals offer limited solutions.

The Albuquerque Bikeways and Trails ~~Master Facility~~ Plan ~~Update~~ Design Guidelines are designed to provide an extensive range of design options for bikeways and trail treatments. These design concepts are based on current bikeway and trail design guidelines for typical situations provided in City documents, including:

- City of Albuquerque *Development Process Manual* (DPM)
- City of Albuquerque *Trails & Bikeways Plan*, 2000
- City of Albuquerque *Comprehensive On-Street Bicycle Plan*, 1993

In addition, the Association of State Highway and Transportation Officials (AASHTO) 2000 Guide for the Development of Bicycle Facilities and the Manual of Uniform Traffic Control Devices (MUTCD) 2003, Part 9 Traffic Controls for Bicycle Facilities and 2009 update were also used. The Albuquerque Bikeways and Trails ~~Master Facility~~ Plan ~~Update~~ Design Guidelines use these documents as a baseline for minimum conditions. In addition to the current standards, an innovative design treatments section follows the design guidelines and provides creative solutions that have been used nationally and internationally to provide ~~safe~~ ~~improved~~ bikeways that are appealing to a wide range of users.

The following are key principles for these pedestrian and bicycle guidelines:

- The bicycling and trail environment should ~~be safe~~ make users feel at ease. Bike routes, pathways, and crossings should be designed and built to be free of hazards and to minimize conflicts with external factors such as noise, vehicular traffic and protruding architectural elements.
- The bikeway and trail network should be as accessible as possible. Bike routes, pathways, and crosswalks should ensure the mobility of all users by accommodating the needs of people regardless of age or ability. Bicyclists have a range of skill levels, and facilities should be designed for use by experienced cyclists at a minimum, with a goal of providing for inexperienced/recreational bicyclists (especially children and seniors) to the greatest extent possible. In areas where specific needs have been identified (e.g., near schools) the needs of appropriate types of bicyclists should be accommodated.
- The bikeway and trail network should connect to places people want to go. The bikeway and trail network should provide continuous direct routes and convenient connections between destinations, including homes, schools, shopping areas, public services, recreational opportunities and transit.
- The bicycling and trail environment should be easy to use. Bike routes, pathways, and crossings should be designed so people can easily find a direct route to a destination and delays are minimized. Most roads in Albuquerque are legal for the use of bicyclists, meaning that most streets are bikeway facilities and should be designed, marked, and maintained accordingly.
- The bikeway and trail environment should create good places. Good design should enhance the feel of the bicycle and trail environment. A complete network of on-street bikeway facilities should connect seamlessly to the existing and proposed off-street pathways to complete recreational and commuting routes around the city.
- Bikeway and trail improvements should be economical. Improvements should be designed to achieve the maximum benefit for their cost, including initial cost and maintenance cost as well as reduced reliance on more expensive modes of transportation. Where possible, improvements in the right-of-way should stimulate, reinforce, and connect with adjacent private improvements.

Design guidelines are intended to be flexible and can be applied with professional judgment by designers. Specific national and state guidelines are identified in this document, as well as design treatments that may exceed these guidelines.

1. National and State Guidelines/Best Practices

The following is a list of references and sources used to develop design guidelines for the Albuquerque Bikeways and Trails ~~Master Facility~~ Plan ~~Update~~-Design Guidelines. Many of these documents are available online and are a wealth of information and resources that are available to the public.

[In the evaluation of facilities, it should be considered whether the AASHTO or NACTO standards are more appropriate when there is conflict between the two guiding documents. When it comes to bikeways and trails in the developed urban portions of the city, the NACTO Urban Bikeway Design](#)

Guide shall be the governing document in the event of conflict with the AASHTO document, unless the project funding stipulates otherwise. There should be documentation of which standards were selected and why.

2. Federal Guidelines

- [Urban Bikeway Design Guide. 2014. National Association of City Transportation Officials \(NACTO\).](#)
- AASHTO *Guide for the Development of Bicycle Facilities*, 1999/2012. American Association of State Highway and Transportation Officials, Washington, D.C. www.transportation.org
- AASHTO *Policy on Geometric Design of Streets and Highways*, 2001. American Association of State Highway and Transportation Officials, Washington, D.C. www.transportation.org
- *Manual on Uniform Traffic Control Devices (MUTCD)*, 2003. Federal Highway Administration, Washington, D.C. <http://mutcd.fhwa.dot.gov>
- [Public Rights-of-Way Accessibility Guidelines \(PROWAG\)](#), 2007. United States Access Board, Washington, D.C. <http://www.access-board.gov/PROWAC/alterations/guide.htm>
- [ADA Final Guidelines for Outdoor Developed Areas, 2013. United States Access Board, Washington D.C.](#)
- *Regulatory Negotiation Committee on Accessibility Guidelines for Outdoor Developed Areas Final Report*, 1999, U.S. Access Board. <http://www.access-board.gov/outdoor/outdoor-rec-rpt.htm>

3. State and Local Guidelines

- City of Albuquerque *Development Process Manual*. www.cabq.gov/planning/dpm/dpm.html
- Albuquerque Municipal Development Department, *Neighborhood Traffic Management Standards*.
- New Mexico Department of Transportation, *New Mexico Bicycle-Pedestrian-Equestrian Advisory Plan*, 2009.
- New Mexico *Comprehensive Transportation Safety Plan (CTSP)*, 2009.
www.nmshtd.state.nm.us/upload/images/Traffic_Safety/pdf/DR3_NMDOT_Safety%20Plan%20Strategie_COMPLETE.pdf
- New Mexico. (1978). *Night Sky Protection Act*. (Section 74-12-11 NMSA 1978)
www.law.justia.com/newmexico/codes/nmrc/jd_74-12-3-1b725.html

Best Practices Documents

- FHWA Report HRT-04-100, *Safety Effects of Marked Versus Unmarked Crosswalks at Uncontrolled Locations*. www.tfhr.gov/safety/pubs/04100/
- FHWA. (2001). *Designing Sidewalks and Trails for Access*
www.fhwa.dot.gov/environment/sidewalk2/contents.htm
- *Road Diet Handbook: Setting Trends for Livable Streets*. 2006. Jennifer Rosales.
- *Bicycle Facility Selection: A Comparison of Approaches*. Michael King, for the Pedestrian and Bicycle Information Center. Highway Safety Research Center, University of North Carolina – Chapel Hill, August 2002. www.bicyclinginfo.org/pdf/bikeguide.pdf

- [APBP Bicycle Parking Guidelines.](http://c.ymcdn.com/sites/www.apbp.org/resource/resmgr/publications/bicycle_parking_guidelines.pdf)
http://c.ymcdn.com/sites/www.apbp.org/resource/resmgr/publications/bicycle_parking_guidelines.pdf
- *Bicycle Parking Design Guidelines.* www.bicyclinginfo.org/pdf/bikepark.pdf
- *City of Chicago Bike Lane Design Guide.* www.bicyclinginfo.org/pdf/bike_lane.pdf
- *The North Carolina Bicycle Facilities Planning and Design Guidelines*, 1994. NCDOT Division of Bicycle and Pedestrian Transportation.
www.ncdot.org/transit/bicycle/projects/resources/projects_facilitydesign.html
- *Wisconsin Bicycle Facility Design Handbook.* 2004. Wisconsin Department of Transportation.
www.dot.wisconsin.gov/projects/bike.htm
- *Florida Bicycle Facilities Planning and Design Handbook.* 1999. Florida Department of Transportation.
www.dot.state.fl.us/safety/ped_bike/ped_bike_standards.htm#Florida%20Bike%20Handbook
- *Oregon Bicycle and Pedestrian Plan.* 1995 Oregon Department of Transportation.
www.oregon.gov/ODOT/HWY/BIKEPED/planproc.shtml
- *City of Portland (OR) Bicycle Master Plan.* 1998. City of Portland (OR) Office of Transportation.
www.portlandonline.com/shared/cfm/image.cfm?id=40414
- *Vélo Québec.* 2003. Technical Handbook of Bikeway Design.
- ~~*Urban Bikeway Design Guide.* 2014. National Association of City Transportation Officials (NACTO).~~
- *Sign Up for the Bike: Design Manual for a Cycle Friendly Infrastructure (CROW).* 2006. Record 25: Design Manual for Bicycle Traffic. CROW, The Netherlands.
- *Trail Solutions: IMBA's Guide to Building Sweet Singletrack,* 2004. International Mountain Bicycling Association.

The AASHTO Guide for the Development of Bicycle Facilities, 2012 edition (the Bike Guide) has an extensive section of design guidelines for Shared Use Paths, covering the following categories:

- Separation between Shared Use Paths and Roadways
- Width and Clearance
- Design Speed
- Horizontal Alignment
- Grade
- Sight Distance
- Path-Roadway Intersections
- Signing and Marking
- Other issues, such as Lighting; Restriction of Motor Vehicles; Railroad Crossings; etc.

Rather than duplicating the referenced design guidance here, this document will instead focus on issues and criteria specific to Albuquerque's multi-use trail system. The remainder of the material from the

AASHTO *Bike Guide* is incorporated herein by reference. In the event of a conflict with this or future versions of the referenced Guides, the more stringent criteria will apply.

The Federal Highway Administration's *Manual on Uniform Traffic Control Devices* (MUTCD), Part 9: Traffic Control for Bicycles, is the accepted reference for most matters relating to signage, signalization, and striping of bicycle trails. The MUTCD offers three levels of information: Standards, which must be followed; Guidance, which is recommended, but not required; and Options, which are permitted, and may or may not be followed, at the discretion of the local authority. The guidelines presented in the MUTCD should be followed in the design of Albuquerque's bikeways and trails.

B. Interagency Coordination Processes

1. Shared Use of Irrigation Ditches (7.C.4.c)

Any trail proposal for an MRGCD owned or managed facility has to be reviewed and approved by us for adequate right of way, current management and maintenance of that facility, landownership and ability for another local entity to manage and maintain the trail through a license agreement. The size of the facility and available right-of-way are strong determinants in the feasibility of a multi-use trail that can be separated from the MRGCD's required maintenance access. Other than at road crossings, rails and fences are generally not installed along ditch banks as they prevent or impede our access and maintenance.

Equestrians use unimproved maintenance roads and trails on our facilities and generally keep distance from bicycles and other fast moving users. Our ditches and drains are used by and very important to equestrians in the valley and we try to provide or maintain access wherever feasible/desirable.

Wherever possible, multi-use trails should meet ADA standards for design and access. It's helpful to make them higher in elevation than the maintenance road for drainage and so less material migrates onto the trail. The opinion about bollards is that they can cause some hazards on a trail but we are increasingly using them rather than the horse log step-overs to provide better access for those who have more mobility issues, bicycles, strollers, etc. while excluding vehicles and four and three wheelers (ATVs).

The trail corridors proposed for the Corrales Main Canal and Alameda Drain will need more study for feasibility. Some funding has been allocated for the Alameda Drain from Matthew Ave. north to Alameda Blvd. and reconnaissance and coordination efforts have commenced.

It would be good for the MRGCD, City and County to develop maintenance and management standards and signage/information more specific to trails on MRGCD facilities as the concerns, management, opportunities and purposes are unique.

2. Shared Use of Utility Corridors

PNM transmission rights-of-way or easements are identified as the location for several proposed bike routes or trails. As the easement holder, PNM has the legal right to use and maintain the easement including ensuring vehicular access to the lines, maintaining adequate clearances, and other safety measures. If the bike lanes and/or trails become guest uses at these locations, an encroachment agreement will be necessary. The City also needs to directly contact the underlying property owner. In addition, it will be the City of Albuquerque's responsibility to ensure that PNM's uses of the easement are not affected or interfered with in any way by the inclusion of the bike lane or trail.

Four proposed bike lane and/or trail locations are identified within PNM's 115kV transmission rights-of-way and easements. The four locations are:

- Along the PNM CE 115kV transmission line from Irving Blvd. NW heading north toward McMahan Blvd. NW
- Along the PNM BW 115kV transmission line north of Interstate 40 east of Atrisco Vista Blvd NW
- Along the PNM SE 115kV transmission line/ID 46kV transmission line corridor in Tijeras Arroyo
- Along the PNM RE/ER 115kV transmission line corridor on San Antonio Drive NE just west of Tramway Blvd NE

Based on PNM's experience constructing and maintaining facilities at these locations, the terrain is difficult and is not conducive for bike trails. Coordination with PNM will be necessary as trails are developed at any of these four locations.

PNM does not support the development of trails within PNM existing 345kV transmission line rights-of-way or easements. The higher voltage lines can potentially result in electrical nuisance shocks. Nuisance shocks may occur when a person touches an ungrounded metal object, in this case, such as bicycle handlebars. A nuisance shock does not harm the recipient but can be startling. PNM will not grant an encroachment easement in 345kV transmission corridors.

3. New Mexico Department of Transportation (NMDOT)

Any trail, lane, and route proposal for a NMDOT roadway facility will require review and approval by NMDOT for the following, but not limited to, adequate right-of-way, accessibility, connectivity, maintenance of the facility and need for license agreement.

As we had discussed, bringing some of the other agency coordination text referring to ADA compliance, design, feasibility, etc. to the introductory section would cover these items for all affected agencies.

C. On-Street Facilities

1. Facility Selection

There are a wide variety of techniques for selecting the type of facility for a given context. Roadway characteristics that are often used include:

- Motor vehicle speed and volume
- Demand for bikeway facilities
- Presence of heavy vehicles/trucks
- User preference
- Roadway width
- Land use/urban or rural context

There are no specific rules for determining the most appropriate type of facility for a particular location; engineering judgment and planning skills are critical elements of this decision.

A 2002 study combined bikeway dimension standards for ten different communities in North America. The goal of the study was to survey the varying requirements available and provide a best practices approach for providing bikeway facilities. The study included a comparison with European standards and found that: “North Americans rely much more on wide lanes for bicycle accommodation than their counterparts overseas.” The table below shows the results of this analysis, which recommends use of bike lanes or shoulders, wide lanes, or normal lanes.

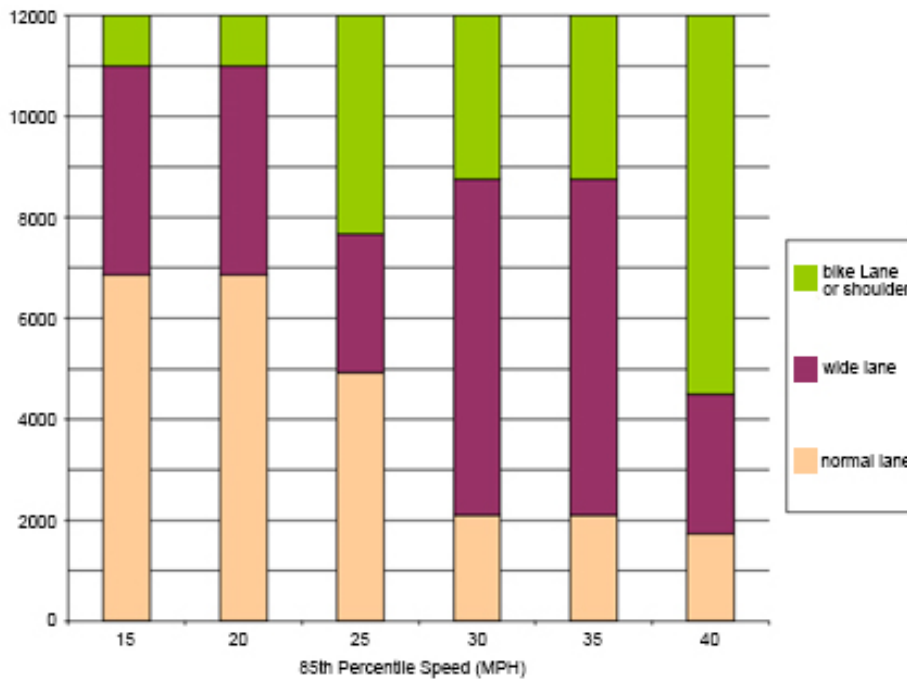

Table 1: North American Bicycle Facility Selection Chart (King, Michael. (2002). Bicycle Facility Selection: A Comparison of Approaches. Pedestrian and Bicycle Information Center and Highway Safety Research Center, University of North Carolina – Chapel Hill.)

The City adopts this table as its guidance for determining the appropriate facility type. In the future, traffic volume and road speeds may be different from the conditions when this plan was adopted. When new bikeways and trails facilities are being planned, designers should consult this table to ensure that the proposed facility type is appropriate.

2. Shared Roadways

Design Summary

- Any street without specific bikeway facilities where bicycling is permitted.
- Can be signed connections, often to trails or other major destinations.
- Sign R4-11 BICYCLES MAY USE FULL LANE may be used on roadways where no bicycle lanes or adjacent shoulders usable by bicyclists are present and where travel lanes are too narrow for bicyclists and motor vehicles to operate side by side (MUTCD Section 9B.06).

Discussion

A treatment appropriate for commuter riders and those accessing a trail, shared roadways can provide a key connection. Shared roadways are indicated exclusively by signage, which provide key connections to destinations and trails where providing additional separation is not possible.

Roadways appropriate for shared roadways often have a centerline stripe only and no designated shoulders. Bicyclists are forced to share a travel lane with automobiles. This type of facility can be developed on a rural roadway without curbs and gutters. It can also be used on an urban road where traffic speeds and volumes are low, although shared lane markings in addition to signage may be more appropriate in these locations.

Guidance

- The City of Albuquerque Development Process Manual (DPM) defines shared roadways as, “any roadway that may be legally used by both motor vehicles and bicycles and is not specifically designated as a bikeway.”
- The DPM states that, “where trails intersect with the street network, safe connections to the on-street bikeway system should be designed.” Shared routes may be an appropriate treatment for such connections.
- See also: MUTCD Section 9B. 20 Bicycle Guide Signs.

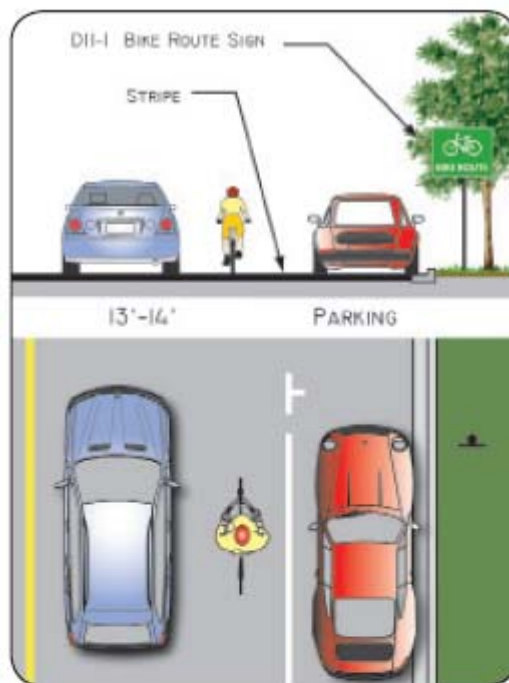

Shared roadway recommended configuration.



This bike route in Los Angeles provides a wide outside lane adjacent to on-street parking.

3. Shoulder Bikeways

Design Summary

DPM recommended widths (measured from painted edge-line to edge of pavement):

- 6 feet on roadways with posted speed limits of 40 mph or greater.
- 5 feet on roadways with posted speed limits of 35 mph or below.
- 4 feet may be considered on low-speed, low-volume streets where right-of-way constraints exist.
- Can include pavement markings and Share the Road signage.
- See bike lane section (Page 12) for additional guidance for determining if bike lanes are required.

Discussion

On streets without adequate space for bike lanes or on rural roads with a large shoulder, shoulder bikeways can accommodate bicycle travel. Shoulder bikeways are generally used by commuter and long-distance recreational riders, rather than families with children or more inexperienced riders.

In many cases, the opportunity to develop a full standard bike lane on a street where it is desirable may be many years. It is possible to stripe the shoulder in lieu of bike lanes if the area is 50 percent of the desirable bike lane width and the outside lane width can be reduced to the American Association of State Highway and Transportation Officials (AASHTO) minimum. If the available bike lane width is two-thirds of the desirable bike lane width, the full bike lane treatment of signs, legends and an 8-foot bike lane line would be provided. Where feasible, extra width should be provided with pavement resurfacing jobs, but not exceeding desirable bike lane widths.

Guidance

The DPM states that, “paved shoulder bikeways are located on uncurbed arterials and collectors and consist of a smooth paved surface that covers all or part of the roadway shoulder.” The DPM also

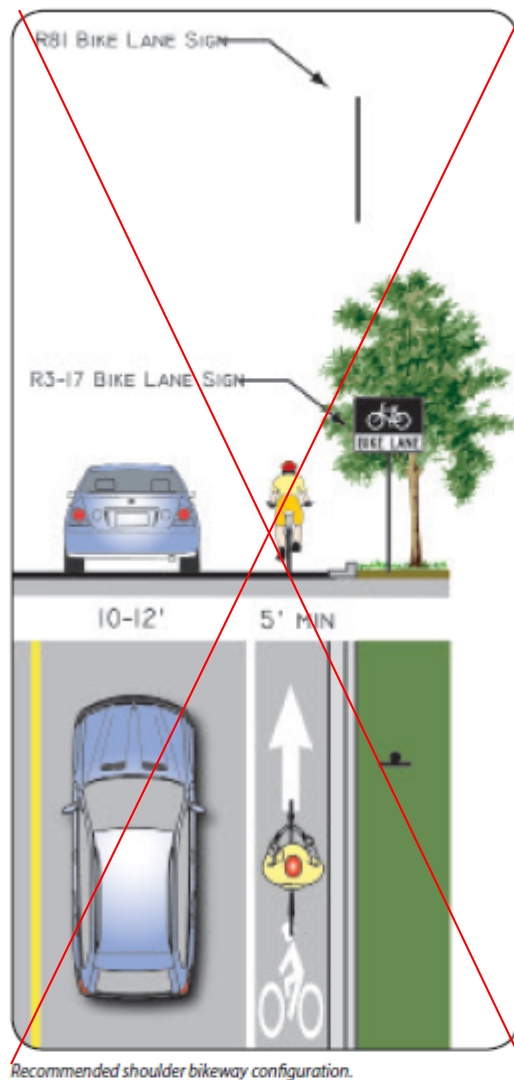

Shoulder bikeways are appropriate along wide rural roads where vehicles can avoid passing close to bicyclists.

specifies that bike lanes and paved shoulders are the standard treatments for use on arterial or collector streets.

The New Mexico Bicycle-Pedestrian-Equestrian Advisory Plan provides guidance on the use of rumble strips to provide a buffer on roadway shoulders. It also has information about guard rails, pavement edges and shoulder continuity.

See also: MUTCD Section 9B. 20 Bicycle Guide Signs.

4. Wide Curb Lane

Design Summary

Outside lane widths of 14-16 feet (DPM) or 14-15 feet (NM BPE Plan).

- The width of the door zone is generally assumed to be 2.5 feet from the edge of the parking lane.
- Place in a linear pattern along a corridor (typically every 100-200 feet).

Recommended Placement:

- At least 11 feet from face of curb (or shoulder edge) on streets with on-street parking.
- At least 4 feet from face of curb (or shoulder edge) on streets without on-street parking.

Discussion

On wide curb lane bikeways, high-visibility pavement markings, called shared lane markings (also known as sharrows), are used to position bicyclists within the travel lane. These markings are often used on streets where dedicated bike lanes are desirable but are not possible due to physical or other constraints. Shared lane markings are placed strategically in the travel lane to alert motorists of bicycle traffic, while also encouraging cyclists to ride at an appropriate distance from the “door zone” of adjacent parked cars. Shared lane markings also encourage cyclists to ride in a straight line so their movements are predictable to motorists. Shared lane markings made of thermoplastic tend to last longer than painted ones.

Guidance

The 2009 MUTCD notes that shared lane markings should not

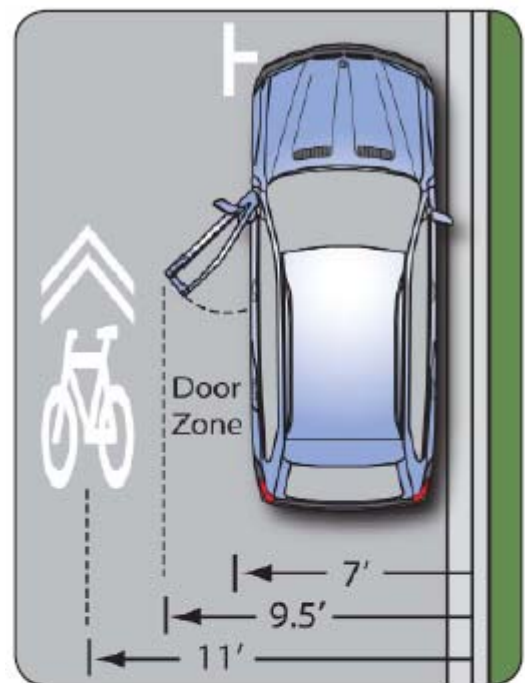

Shared lane marking placement guidance for streets with on-street parking.



Shared lane markings are currently used in Albuquerque.

be placed on roadways with a speed limit over 35 mph, and that when used the marking should be placed immediately after an intersection and spaced at intervals no greater than 250 feet thereafter. Placing shared lane markings between vehicle tire tracks (if possible) will increase the life of the markings. (See MUTCD Section 9C.07).

5. Bike Lanes

Design Summary

Designated exclusively for bicycle travel, bike lanes are separated from vehicle travel lanes with striping and also include pavement stencils. Bike lanes are most appropriate on arterial and collector streets where higher traffic volumes and speeds warrant greater separation.

The DPM recommends minimum bike lane widths of:

- 5 feet, measured from painted edgeline to edge of gutter, on roadways with posted speed limits of 40 mph or greater.
- 4 feet, measured from painted edgeline to edge of gutter, on roadways with posted speed limits of 35 mph or less.

However, AASHTO and other guidance authorities recommends a 5-foot minimum for bike lanes, with 4 feet only in restricted corridors. This text should be considered for revision to specify that a 5-foot bike lane is recommended on streets with posted speed limits of 35 mph or less. In addition, the DPM should specify that bike lanes are measured to the inside edge of the gutter pan, ensuring smooth pavement rather than a gutter edge in the bike lane.

Discussion

Many bicyclists, particularly less experienced riders, are more comfortable riding on a busy street if it has a striped and signed bike lane than if they are expected to share a wide lane. Providing marked facilities such as bike lanes is one way of helping to persuade more tentative riders to try bicycling.

Bike lanes can increase safety-the feeling of security and promote proper riding by:

- Defining road space for bicyclists and motorists, reducing the possibility that motorists will stray into the cyclists' path
- Discouraging bicyclists from riding on the sidewalk
- Reminding motorists that cyclists have a right to the



Recommended shoulder bikeway configuration.



Bike lane pavement markings in Portland, Oregon provide character to the roadway.

road.

In an urban setting, it is crucial to ensure that bike lanes and adjacent parking lanes have sufficient width, so that cyclists have enough room to avoid opened vehicle doors.

Additional Guidance

The DPM defines a bike lane as, “a lane on the roadway that has been designated by striping, signing and pavement markings for preferential or exclusive use by bicyclists.” The DPM recommends the provision of bike lanes on all new or reconstructed arterial and collector roadways.

The DPM also specifies that high-speed traffic (posted speed of 40 mph or greater) and the presence of large vehicles (truck, bus or recreational vehicle) are significant factors affecting the acceptability of potential bikeway locations. In locations where these conditions exist, bike lane widths of 5-foot or greater are recommended.

The AASHTO Guide for the Development of Bicycle Facilities guideline states that, “If used, the bicycle lane symbol marking shall be placed immediately after an intersection and other locations as needed... If the word or symbol pavement markings are used, Bicycle Lane signs shall also be used, but the signs need not be adjacent to every symbol to avoid overuse of the signs.”

The New Mexico Bicycle and Pedestrian Plan specifies that, “A vertical edge of pavement should not be left in the useable shoulder area or bicycle lane after construction or maintenance,” stating that 4 feet (minimum) of clear space should be provided and noting that partial overlays create undue hazards for cyclists.

See also MUTCD Section 9C.04 Markings for Bicycle Lanes.

Bike Lane Adjacent to On-Street Parallel Parking (7.B.5.a)

Design Summary

Bike Lane Width

- 6 feet recommended when parking stalls are marked.

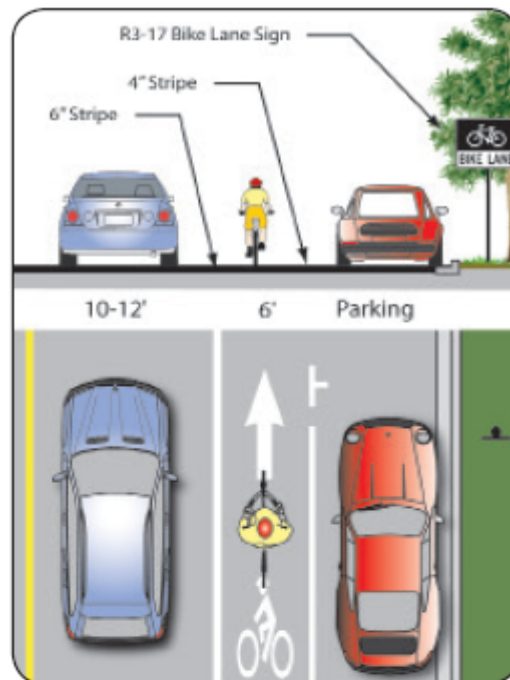

Parking 'T' bike lane design.

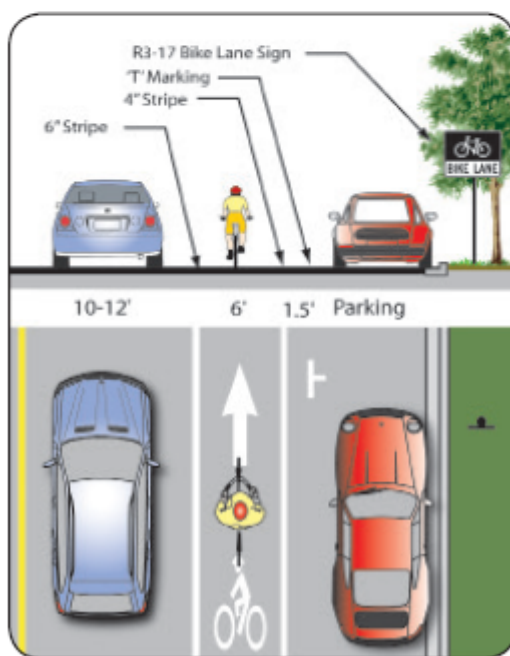

Parking buffer bike lane design.

- 4 feet minimum in constrained locations.
- 5 feet acceptable if parking not marked (drivers tend to park closer to the curb where parking is unmarked).
- 7 feet maximum (greater widths may encourage vehicle loading in bike lane).

Travel Lane Width

- 12 feet for a shared lane adjacent to a curb face.
- 11 feet minimum for a shared bike/parking lane where parking is permitted but not marked on streets without curbs.

Discussion

Bike lanes adjacent to on-street parallel parking are common in the U.S. and can be dangerous for bicyclists if not designed properly. Crashes caused by a suddenly opened vehicle door are a common hazard for bicyclists using this type of facility. On the other hand, wide bike lanes may encourage the cyclist to ride farther to the right (door zone) to maximize distance from passing traffic. Wide bike lanes may also cause confusion with unloading vehicles in busy areas where parking is typically full.

Some treatments to encourage bicyclists to ride away from the door zone include:

- Installing parking “T’s” and smaller bike lane stencils placed to the left (see graphic at top).
- Provide a buffer zone (preferred design; shown bottom). Bicyclists traveling in the center of the bike lane will be less likely to encounter open car doors. Motorists have space to stand outside the bike lane when loading and unloading.

Guidance

From AASHTO Guide for the Development of Bicycle Facilities:

“If parking is permitted, the bike lane should be placed between the parking area and the travel lane and have a minimum width of 5 feet. Where parking is permitted but a parking stripe or stalls are not utilized, the shared area should be a minimum of 11 feet without a curb face and adjacent to a curb face. If the parking volume is substantial or turnover is high, an additional 1-2 feet of width is desirable.”

Bike Lane Adjacent to On-Street Diagonal Parking ***(7.B.5.b)***

Design Summary

Bike Lane Width

- 5 feet minimum.
- White 4 inch stripe separates bike lane from parking bays.
- White 6 inch stripes separate bike lane from motor vehicle travel lanes.
- Parking bays are sufficiently long to accommodate most vehicles (vehicles do not block bike lane).

Discussion

In areas with high parking demand such as urban commercial areas, diagonal parking can be used to increase parking supply. Conventional “head-in” diagonal parking is not recommended in conjunction with high levels of bicycle traffic or with the provision of bike lanes as drivers backing out of conventional diagonal parking spaces have poor visibility of approaching bicyclists.

The use of back-in diagonal parking or reverse angled parking is recommended over head-in diagonal parking. This design addresses issues with diagonal parking and bicycle travel by improving sight distance between drivers and bicyclists and has other benefits to vehicles including: loading and unloading of the trunk occurs at the curb rather than in the street, passengers (including children) are directed by open doors towards the curb and no door conflict with bicyclists. While there may be a learning curve for some drivers, using back-in diagonal parking is typically an easier maneuver than conventional parallel parking.

Guidance

This treatment is currently slated for inclusion in ~~the upcoming update of~~ the 2012 AASHTO Guide for the Development of Bicycle Facilities.

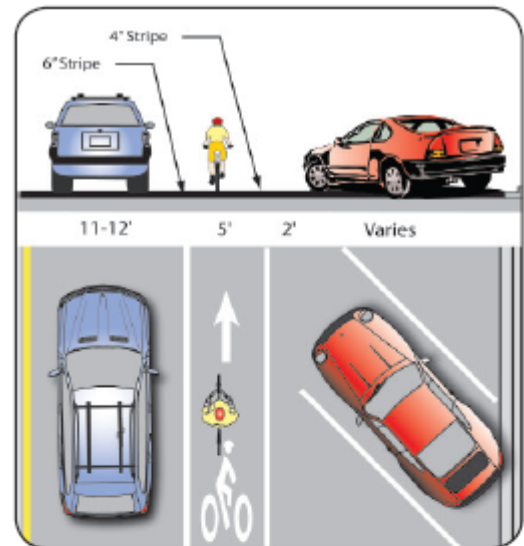

'Back-in' diagonal parking is safer for cyclists than 'head-in' diagonal parking due to drivers' visibility as they exit the parking spot.

Bike Lane Without On-Street Parking (7.B.5.c)

Design Summary

Bike Lane Width

- 4 feet minimum when no curb & gutter is present.
- 5 feet minimum when adjacent to curb and gutter.

Recommended Width

- 6 feet where right-of-way allows.

Maximum Width

- 8 feet adjacent to arterials with high travel speeds (45 mph or more).

Discussion

Wider bike lanes are desirable in certain circumstances such as on higher speed arterials (45 mph or more) where a wider bike lane can increase separation between passing vehicles and cyclists. Wide bike lanes are also appropriate in areas with high bicycle use. A bike lane width of 6-8 feet makes it possible for bicyclists to ride side-by-side or pass each other without leaving the bike lane, increasing the capacity of the lane. Appropriate signing and stenciling is important with wide bike lanes to ensure motorists do not mistake the lane for a vehicle lane or parking lane.

Guidance

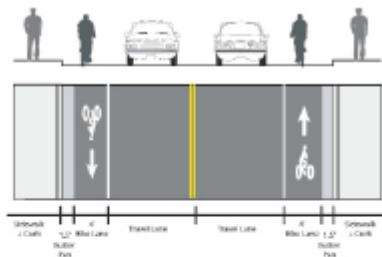

32' Road Curb-to-Curb Width

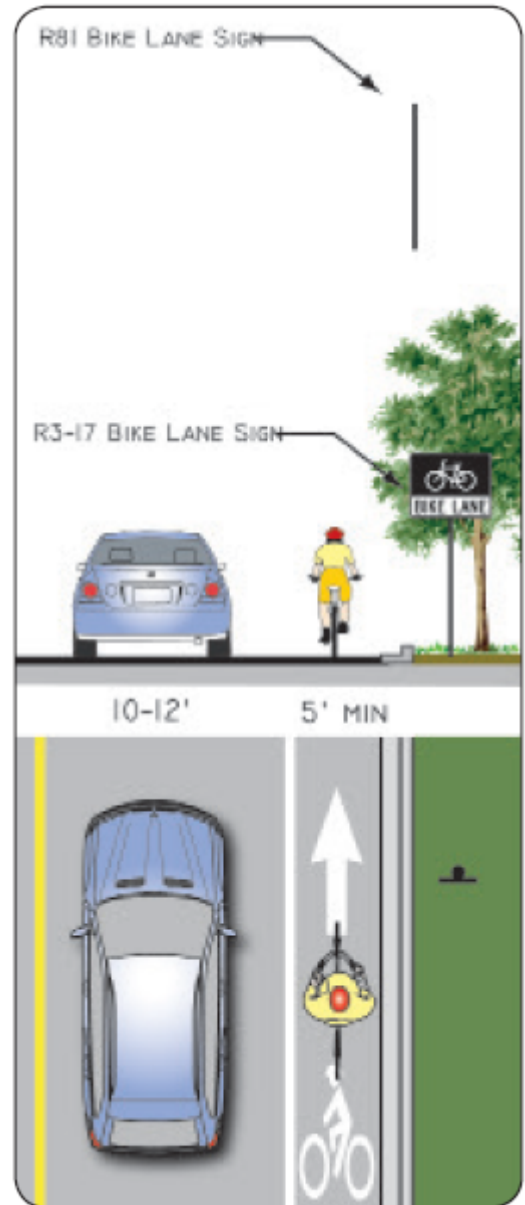
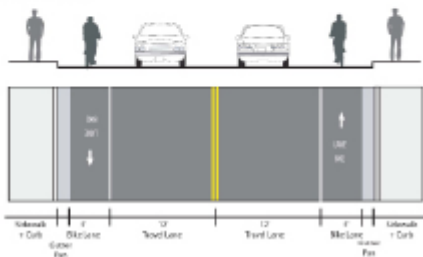

Recommend bike lane without on-street parking design.

Two Lane Cross-Section with No Parking*. *Bike lanes may be 4' in width under constrained circumstances.

Bike Lane Striping at Intersections (7.B.5.d)

Design Summary

- Stop striping bike lanes at painted crosswalks or the near side cross street property line
- At complex intersections, bike lanes may be dotted.
- At signalized or stop-controlled intersections with right-turning motor vehicles or at bus stops on the near side of the intersection, replace the solid striping to the approach should be with a broken line with 2-foot dots and 6-foot spaces for 50 to 200 feet.
- If a bus stop is located on a far side of the intersection, replace the solid white line with a broken line for at least 80 feet from the crosswalk on the far side of the intersection.
- At T-intersections with no painted crosswalks, continue the bike lane striping on the side across from the T-intersection through the intersection area with no break.

Discussion

Bike lane striping should be brought to the crosswalk or property line on the near side of an intersection. Bike lane striping is not continued through intersections, except where high volumes of motor vehicles are turning right, a bus stop is located in advance of or on the far side of the intersection or at a complex intersection. In the example photo from Portland, Ore., bicyclists are directed on the right hand side of a light rail stop, while the road continues to the left. This diversion sets cyclists up to cross the light rail tracks at a 90 degree angle.

Some jurisdictions are experimenting with using shared lane markings or other high-visibility pavement markings through intersections. At high-speed intersections, such as where a highway on- or off-ramp crosses a bike lane, colored pavement can be used to highlight the conflict area (see innovative design guidelines).

Consistency of intersection design and visibility of cyclists travelling in a bike lane should be a priority to accommodate bicyclists through intersections.

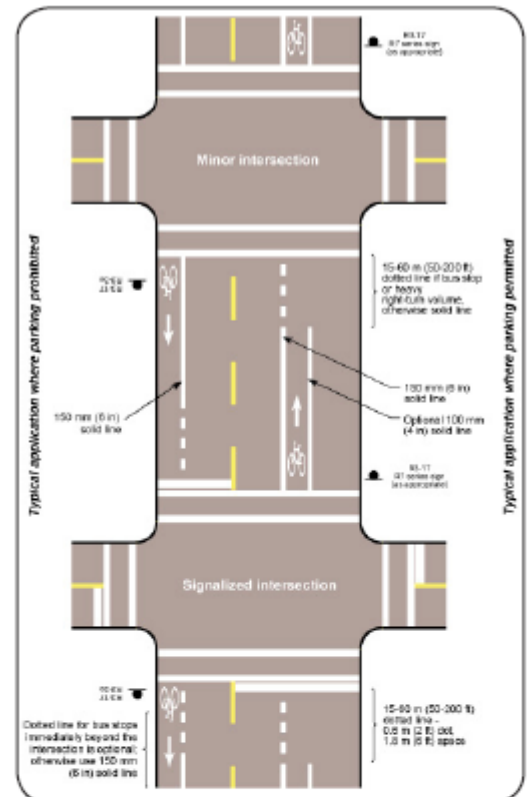

Typical pavement markings for bike lane on two-way street (AASHTO)



Bike lane dashed through complex intersection.

Guidance

AASHTO Guide for the Development of Bicycle Facilities (1999).

Bike Lanes at Roundabouts (7.B.5.e)

Design Summary

- Reduce the speed differential between circulating motorists and bicyclists (25 mph maximum circulating design speed).
- Design approaches/exits to the lowest speeds possible to reduce the severity of potential collisions with pedestrians.
- Encourage bicyclists navigating the roundabout like motor vehicles to “take the lane”
- Maximize yielding rate of motorists to pedestrians and bicyclists
- Provide separated facilities for bicyclists who prefer not to navigate the roundabout on the roadway.
- Indicate to drivers and bicyclists the correct way for them to circulate through the roundabout through appropriately designed signage, pavement markings and geometric design elements.
- Indicate to drivers, bicyclists and pedestrians the right-of-way rules through appropriately designed signage, pavement markings and geometric design elements.

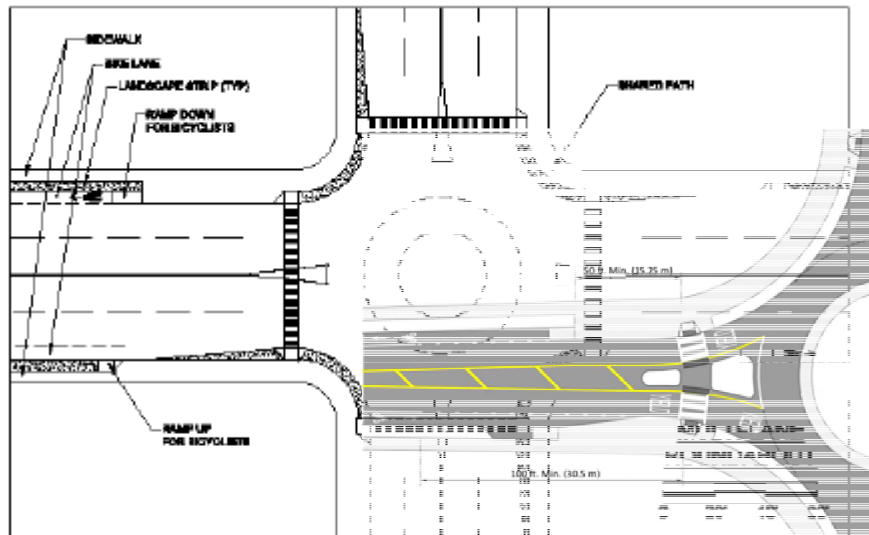

Recommended bike lane at roundabout design.

(Source: UC Berkeley Traffic Safety Center for Caltrans, Collision Rates and Bicyclist and Pedestrian Demand)

Discussion

Research indicates that while single-lane roundabouts may benefit bicyclists and pedestrians by slowing traffic, multi-lane roundabouts may significantly increase safety-potential problems for these users.

Multi-lane roundabouts pose the following challenges to bicyclists riding in a bike lane:

- Bicyclists must take the lane before they enter the roundabout to avoid becoming caught in a “right hook,” a situation in which a motorist turns right, across the path of a bicyclist traveling straight. Entry leg speeds must be slow enough for bicyclists to be able to take the lane safely, securely merge with traffic.
- Theoretically, once motor vehicle volumes reach a certain magnitude, there are no gaps in traffic large enough to accommodate a bicyclist.
- Bicyclists must be able to correctly judge the speed of circulating motorists to find a gap that is large enough for them to safely enter effectively merge in the roundabout. This task is particularly difficult if the circulating motorists are traveling at a much higher speed than the bicyclists. In

addition, if circulating speeds in a roundabout are much higher than 20 mph, drivers behind a bicyclist may become impatient and may pass the bicyclist and turn in front of him, creating more risks for the bicyclist.

- As a circulating bicyclist approaches an entry lane, a driver waiting to enter must notice the bicyclist, properly judge the bicyclist's speed and yield to him/her if necessary. In a location where there are few bicyclists, motorists may not even register that there is a bicyclist approaching. If a bicyclist is hugging the curb, s/he may be outside the motorist's cone of vision.

Guidance

The New Mexico Bicycle-Pedestrian-Equestrian Advisory Plan state provides additional guidance for providing bicycle travel around roundabouts.

Retrofitting Existing Streets with Bike Lanes - Roadway Widening (7.B.5.f)

Most major streets in Albuquerque are characterized by conditions (e.g., high vehicle speeds and/or volumes) for which dedicated bike lanes are appropriate to easily accommodate ~~safe and~~ comfortable riding. Although opportunities to add bike lanes through roadway widening may exist in some locations, most major streets in Albuquerque pose physical and other constraints requiring street retrofit measures within existing curb-to-curb widths. As a result, many of the recommended measures effectively reallocate existing street width through striping modifications to accommodate dedicated bike lanes.

The DPM notes that, "the addition of bike lanes as part of arterial and collector rehabilitation is recommended where feasible." While largely intended for major streets, these measures may be appropriate on some lower-order streets where bike lanes would best accommodate cyclists.

Design Summary

- 6 feet preferred.
- 4 feet minimum (see bike lane guidance).

Discussion

Bike lanes could be accommodated on several streets with excess right-of-way through shoulder widening. Although street widening incurs higher expenses compared with re-striping projects, bike lanes could be added to streets currently lacking curbs, gutters and sidewalks without the high costs of major infrastructure reconstruction.

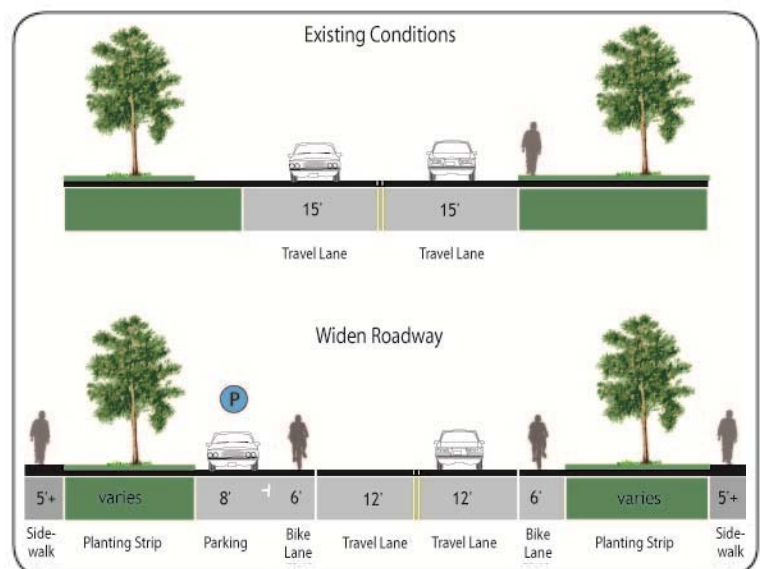

Example of roadway widening to accommodate bike lanes and sidewalks.

As a long-term measure, the City should find opportunities to add bike lanes to other major streets where they are needed. Opportunities include adding bike lanes as streets and bridges are widened for additional auto capacity or as property development necessitates street reconstruction.



This street in Portland, Oregon previously had 13' lanes, which were narrowed to accommodate bike lanes without removing a lane.

Retrofitting Existing Streets with Bike Lanes - Lane Narrowing (Road Diet 1) (7.B.5.g)

Design Summary

Vehicle Lane Widths

- Before: 12-15 feet; after: 10-11 feet.

Bike Lane Width

- See bike lane design guidance.

Discussion

Also called a 'Road Diet,' lane narrowing utilizes roadway space that exceeds minimum standards to create the needed space to provide bike lanes. Many roadways in Albuquerque have existing lanes that are wider than those prescribed in local and national roadway design standards, or which are not marked. Most standards allow for the use of 11-foot wide and sometimes 10-foot wide travel lanes to create space for bike lanes.

Special consideration should be given to the amount of heavy vehicle traffic and horizontal curvature before the decision is made to narrow travel lanes. Center turn lanes can also be narrowed in some situations to free up pavement space for bike lanes.

Guidance

Example of vehicle travel lane narrowing to accommodate bike lanes.

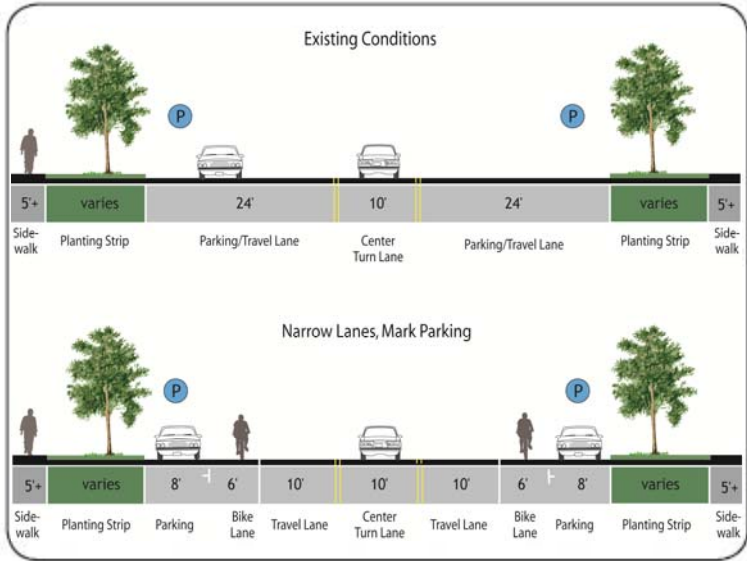

Example of vehicle travel lane narrowing to accommodate bike lanes.

Retrofitting Existing Streets with Bike Lanes - Lane Reconfiguration (Road Diet 2) (7.B.5.h)

Design Summary

Vehicle Lane Widths

- Width depends on project. No narrowing may be needed if a lane is removed.

Bike Lane Width

- See bike lane design guidance.

Discussion

The removal of a single travel lane will generally provide sufficient space for bike lanes on both sides of a street. Streets with excess vehicle capacity provide opportunities for bike lane retrofit projects. Depending on a street's existing configuration, traffic operations, user needs and ~~safety concerns~~ access demands, various lane reduction configurations exist. For instance, a four-lane street (with two travel lanes in each direction) could be modified to include one travel lane in each direction, a center turn lane and bike lanes. Prior to implementing this measure, a traffic analysis should identify impacts.

This treatment is slated for inclusion in ~~the update to the~~ 2012 AASHTO Guide for the Development of Bicycle Facilities.

Guidance

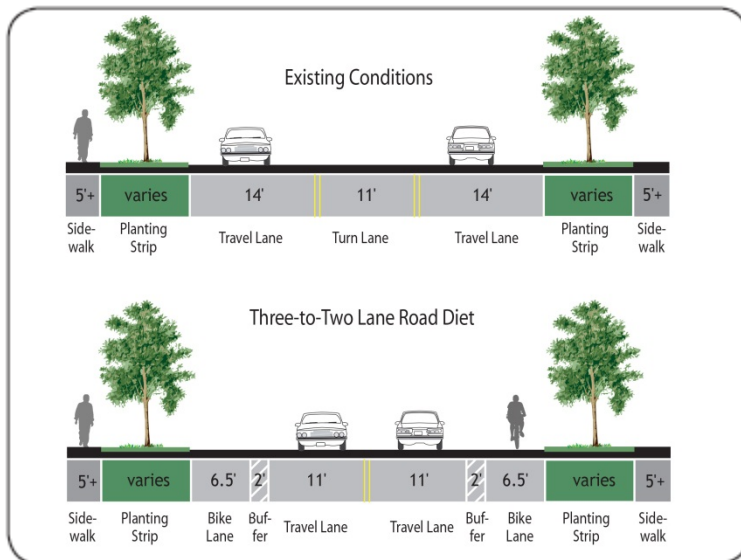

Example of vehicle travel lane reconfiguration to accommodate bike lanes.



This road was re-striped to convert four vehicle travel lanes into three travel lanes with bike lanes.

Retrofitting Existing Streets with Bike Lanes - Parking Reduction (Road Diet 3) (7.B.5.i)

Design Summary

Vehicle Lane Widths

- Width depends on project. No narrowing may be needed depending on the width of the parking lane to be removed.

Bike Lane Width

- See bike lane design guidance.

Discussion

Bike lanes could replace one or more on-street parking lanes on streets where excess parking exists and/or the importance of bike lanes outweighs parking needs. For instance, parking may be needed on only one side of a street (as shown below and at right). Eliminating or reducing on-street parking also improves sight distance for cyclists in bike lanes and for motorists on approaching side streets and driveways. Prior to reallocating on-street parking for other uses, a parking study should be performed to gauge demand and to evaluate impacts to people with disabilities.

Guidance

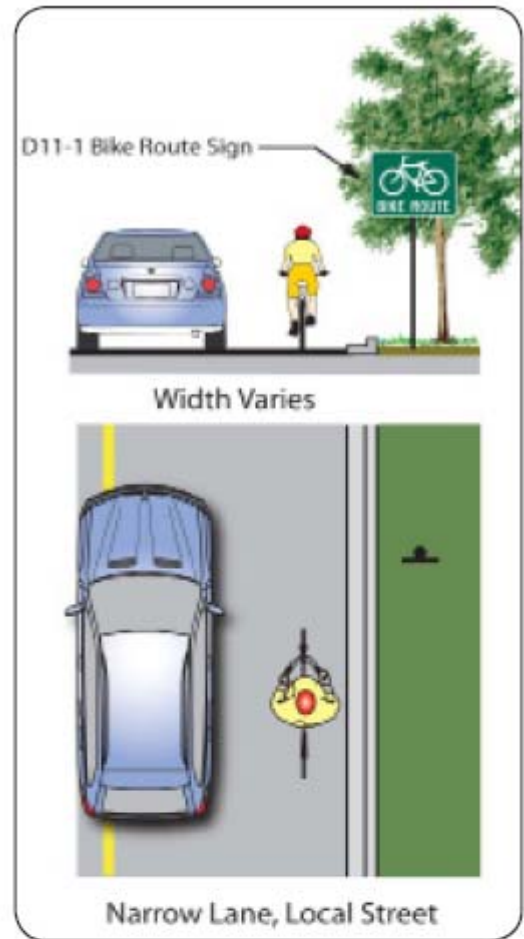
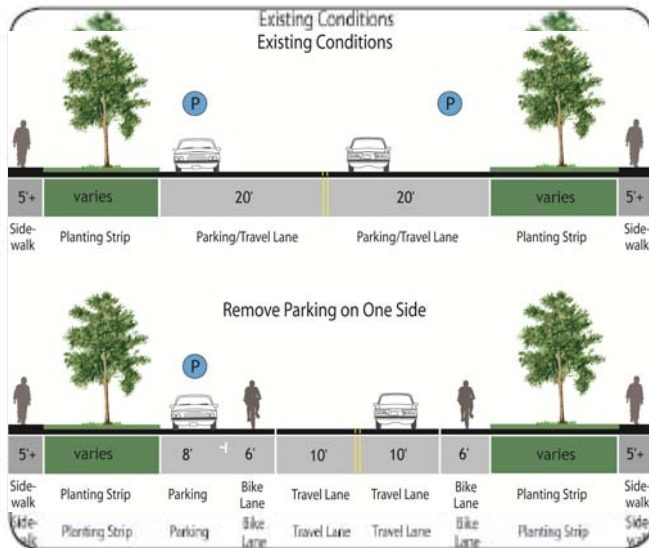

Recommended design for bike routes/ bicycle boulevards.



6. Bicycle Boulevards

Design Summary

- Roadway width varies depending on roadway configuration.
- Use D11-1 “Bike Route” sign as specified for shared roadways.
- Shared lane markings may be applied.
- Intersection treatments, traffic calming and traffic diversions can be utilized to improve the cycling environment, as recommended in the following pages.



Bicycle boulevards are low-speed streets that provide a comfortable and pleasant experience for cyclists.

Discussion

Treatments for bicycle boulevards include five application levels, which are rated based on their level of physical intensity. This helps identify the appropriate application level for individual bicyclists. Level one represents the least physically intensive treatments that could be implemented at a relatively low cost.

Traffic calming and other treatments along the corridor reduce vehicle speeds so that motorists and bicyclists generally travel at the same speed, creating a more-comfortable environment for all users. Bicycle boulevards incorporate treatments to facilitate convenient crossings where the route crosses a major street. They work best in well-connected street grids where riders can follow reasonably direct and logical routes and when higher-order parallel streets exist to serve through vehicle traffic.

Bicycle boulevards/bike routes can be treated with shared lane markings, directional signage, traffic diverters, chicanes, chokers and /or other traffic calming devices to reduce vehicle speeds or volumes.

Bicycle boulevards can employ a variety of treatments from signage to traffic calming and pavement stencils. The level of treatment provided at a specific location depends on several factors, discussed below.

Guidance

- The DPM defines a bicycle boulevard as, “a bike route designed to encourage the through movement of bicycles while maintaining local access for motor vehicle travel.”
- Bicycle boulevards have been implemented in California in Berkeley, Emeryville, Palo Alto, San Luis Obispo and Pasadena; in Oregon in Portland and Eugene; in Madison, Wis.; in Vancouver, B.C.; in Tucson, Ariz.; in Minneapolis, Minn.; in Ocean City, Md.; and in Syracuse, N.Y.
- Alta Planning + Design and IBPI. Bicycle Boulevard Planning and Design Handbook. www.ibpi.usp.pdx.edu/guidebook.php
- City of Berkeley. (2000). Bicycle Boulevard Design Tools and Guidelines. <http://www.ci.berkeley.ca.us/contentdisplay.aspx?id=6652>

- AASHTO Guide for the Development of Bicycle Facilities.

Discussion (continued)

Bicycle boulevards serve a variety of purposes:

- **Parallel major streets lacking dedicated bicycle facilities:** Higher-order streets typically include major bicyclist destinations (e.g., commercial and employment areas). However, these corridors often lack bike lanes or other dedicated facilities creating an uncomfortable, unattractive and potentially **unsafe-undesirable** riding environment. Bicycle boulevards serve as alternate parallel facilities that allow cyclists to avoid major streets for longer trips.
- **Parallel major streets with bicycle facilities that are uncomfortable for some users:** Some users may not feel comfortable using bike lanes on major streets due to high traffic volumes and vehicle speeds, conflicts with motorists entering and leaving driveways and/or conflicts with buses loading and unloading passengers. Children and less-experienced riders might find these environments especially challenging. Utilizing lower-order streets, bicycle boulevards provide alternate route choices for these bicyclists. It should be noted that bike lanes on major streets provide important access to key land uses, and the major street network often provides the most direct routes between major destinations. For these reasons, bicycle boulevards should complement a bike lane network and not serve as a substitute.
- **Ease of implementation on most local streets:** bicycle boulevards incorporate cost-effective and less physically-intrusive treatments than bike lanes and cycle tracks. Most streets could be provided relatively inexpensive treatments like new signage, pavement markings, striping and signal improvements to facilitate bicyclists' mobility and **safety protection**. Other potential treatments include curb extensions, medians and other features that can be implemented at reasonable cost and are compatible with emergency vehicle accessibility.

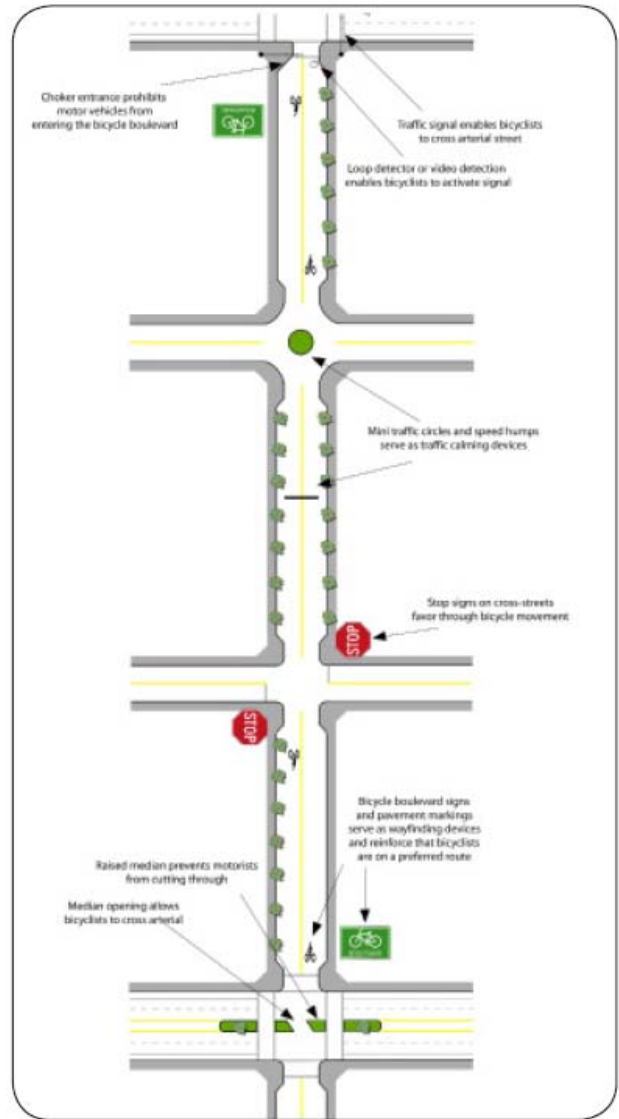

Sample bicycle boulevard treatments.

- Benefits beyond an improved bicycling environment:** Residents living on bicycle boulevards benefit from reduced vehicle speeds and through traffic, creating a **safer and more-attractive, vehicle-restricted** environment. Pedestrians and other users can also benefit from boulevard treatments (e.g., by improving the crossing environment where boulevards meet major streets).

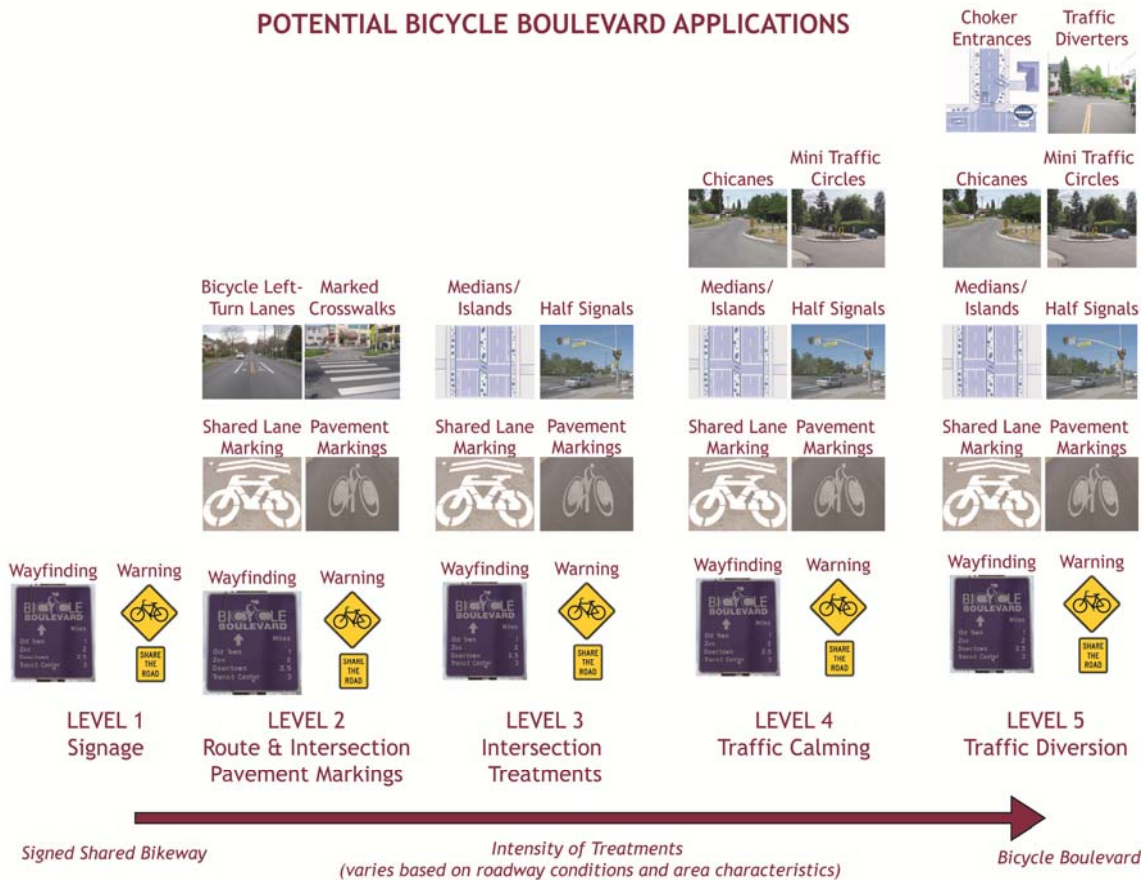

It should be noted that corridors targeted for higher-level applications would also receive relevant lower-level treatments. For instance, a street targeted for Level 3 applications should also include Level 1 and 2 applications as necessary. It should also be noted that some applications may be appropriate on some streets while inappropriate on others. In other words, it may not be appropriate or necessary to implement all Level 2 applications on a Level 2 street. Furthermore, several treatments could fall within multiple categories as they achieve multiple goals. To identify and develop specific treatments for each bicycle boulevard, the City should involve the bicycling community and neighborhood groups. Further analysis and engineering work may also be necessary to determine the feasibility of some applications.

The City should strive to implement bicycle boulevards of Level 3 or higher, with additional traffic calming or diversion as needed.

Bicycle Boulevard Signing (7.B.6.a)

Design Summary

- Signing is a cost-effective and highly visible treatment that can improve the riding environment on a bicycle boulevard.
- The City should adopt consistent signage and paint markings throughout the region.

Discussion

Wayfinding signs are typically placed at key locations leading to and along bicycle boulevards, including where multiple routes intersect and at key bicyclist “decision points.”

Wayfinding signs displaying destinations, distances and “riding time” can dispel common misperceptions about time and distance while increasing users’ comfort and accessibility to the boulevard network.

Wayfinding signs also visually cue motorists that they are driving along a bike route and should correspondingly use caution. Note that too many signs tend to clutter the right-of-way, and it is recommended that these signs be posted at a level most visible to bicyclists and pedestrians, rather than per vehicle signage standards.

Warning signs advising motorists to “share the road” and “watch for bicyclists” may also improve bicycling conditions on shared streets. These signs are especially useful near major bicycle trip generators such as schools, parks and other activity centers. Warning signs should also be placed on major streets approaching bicycle boulevards to alert motorists of bicyclist crossings.

Guidance

- Alta Planning + Design and IBPI. Bicycle Boulevard Planning and Design Handbook. www.ibpi.usp.pdx.edu/guidebook.php
- City of Berkeley. (2000). Bicycle Boulevard Design Tools and Guidelines.
- AASHTO Guide for the Development of Bicycle Facilities.
- MUTCD.



Sample bicycle boulevard signage.



Wayfinding signs help bicyclists stay on designated bike routes.

Level 2: Bicycle Boulevard Pavement Markings (7.B.6.b)

Design Summary

Use pavement markings to designate bicycle boulevards and provide directional/wayfinding information.

Discussion

On-Street Parking Delineation

Delineating on-street parking spaces with paint or other materials clearly indicates where a vehicle should be parked and can discourage motorists from parking their vehicles too far into the adjacent travel lane. This helps cyclists by maintaining a wide enough space to **safely-comfortably** share a travel lane with moving vehicles while minimizing the need to swerve farther into the travel lane to maneuver around parked cars.

In addition to benefiting cyclists, delineated parking spaces also promote the efficient use of on-street parking by maximizing the number of spaces in high-demand areas.

Centerline Striping Removal

Automobiles have an easier time passing cyclists on roads without centerline stripes for the majority of the block length. If vehicles cannot easily pass each other using the full width of the street, it is likely that there is too much traffic for the subject street to be a successful bicycle boulevard. In addition, not striping the centerline reduces maintenance costs.

Berkeley paints a double yellow centerline from 40-50 feet at uncontrolled or stop-controlled intersections, as well as pavement reflectors to identify the center of the street.

Directional Pavement Markings (Non-standard treatment)

Directional pavement markings (also known as bicycle boulevard markings) lead cyclists along a boulevard and reinforce that they are on a designated route. Markings can take a variety of forms, such as small bicycle symbols placed every 600-800 feet along a linear corridor, as previously used on Portland, Oregon's boulevard network.

Recently, jurisdictions have been using larger, more visible



Shared lane markings also provide directional support for bicyclists.

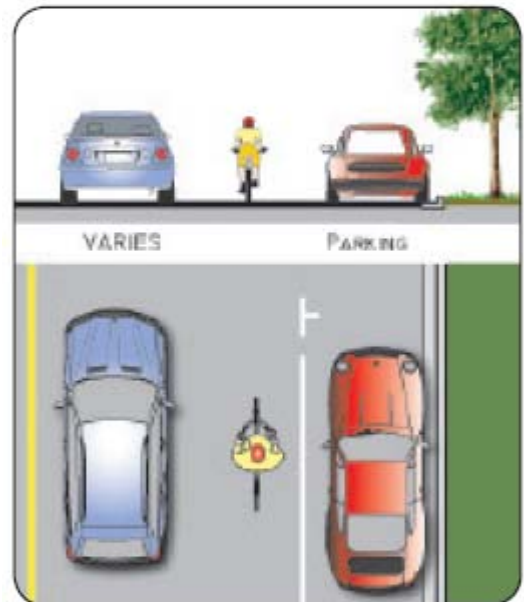

Example of on-street parking delineation.



Bicycle boulevard directional marker.

pavement markings. Shared lane markings could be used as bicycle boulevard markings, as Portland, Ore., has moved towards using. See shared lane marking guidelines for additional information on this treatment.

In Berkeley, Calif., non-standard pavement markings include larger-scale lettering and stencils to clearly inform motorists and bicyclists of a street's function as a bicycle boulevard.

Guidance

- Alta Planning + Design and IBPI. Bicycle Boulevard Planning and Design Handbook.
www.ibpi.usp.pdx.edu/guidebook.php
- City of Berkeley. (2000). Bicycle Boulevard Design Tools and Guidelines.
- AASHTO Guide for the Development of Bicycle Facilities.
- MUTCD.

Level 3: Bicycle Boulevards at Minor Unsignalized Intersections (7.B.6.c)

Design Summary

To encourage use of the boulevard and improve cyclists' ~~safety~~ sense of security, reduce bicycle travel time by eliminating unnecessary stops and improving intersection crossings.

Discussion

Stop Sign on Cross-Street

Unmarked intersections are dangerous for bicyclists because cross-traffic may not be watching for cyclists. Stop signs on cross streets require crossing motorists to stop and proceed when safe the intersection has cleared. Stop signs are a relatively inexpensive treatment that is quite effective at minimizing bicycle and cross-vehicle conflicts. However, placing stop signs at all intersections along bicycle boulevards may be unwarranted as a traffic control device.

The DPM specifies that, "Potential on-street bikeway locations should include no more than one stop sign or traffic signal per 1/4 mile. Local street stop control should be reassigned to



Medians on bicycle boulevards can provide space for a bicyclist to wait.



Stop signs effectively minimize conflicts along bicycle boulevards.



Example of a bicycle left-turn pocket.



Bicycle forward stop bars encourage cyclists to wait where they are more visible.

facilitate through bicycle traffic on designated bikeways. Stop control reassignment requires an engineering study to determine additional measures necessary to minimize neighborhood impacts.”

Curb Extensions and High-Visibility Crosswalks

This treatment is appropriate near activity centers with large amounts of pedestrian activity, such as schools or commercial areas. Curb extensions should only extend across the parking lane and not obstruct bicyclists’ path of travel or the travel lane. Curb extensions and high-visibility crosswalks both calm traffic and also increase the visibility of pedestrians waiting to cross the street, although they may impact on-street parking.

Bicycle Forward Stop Bar (Non-standard treatment)

A second stop bar for cyclists placed closer to the centerline of the cross street than the first stop bar increases the visibility of cyclists waiting to cross a street. This treatment is typically used with other crossing treatments (i.e., curb extension) to encourage cyclists to take full advantage of crossing design. They are appropriate at unsignalized crossings where fewer than 25 percent of motorists make a right turn movement.

Guidance

- Alta Planning + Design and IBPI. Bicycle Boulevard Planning and Design Handbook.
- City of Berkeley. (2000). Bicycle Boulevard Design Tools and Guidelines.
- AASHTO Guide for the Development of Bicycle Facilities.

Level 3: Bicycle Boulevards at Major Unsignalized Intersections (7.B.6.d)

Design Summary

Increase crossing opportunities with medians and refuge islands.

Discussion

Medians/Refuge Islands

A crossing island can be provided to allow cyclists to cross one direction of traffic at a time when gaps in traffic allow. The crossing island should be at least 8 feet wide; narrower medians can accommodate bikes if the holding area is at an acute angle to the major roadway. Crossing islands can be



Chicanes require all vehicles to reduce their speeds.



Traffic circles provide an opportunity for landscaping, but visibility should be maintained.



Speed humps are a common traffic calming treatment, which should not be used on emergency routes.

placed in the middle of the intersection, prohibiting left and through vehicle movements.

Guidance

- Alta Planning + Design and IBPI. Bicycle Boulevard Planning and Design Handbook.
- City of Berkeley. (2000). Bicycle Boulevard Design Tools and Guidelines.
- AASHTO Guide for the Development of Bicycle Facilities.

Level 3: Bike Routes/Boulevards at Offset Intersections [\(7.B.6.e\)](#)

Design Summary

- Provide turning lanes or pockets at offset intersection , providing cyclists with a refuge to make a two-step turn.
- Bike turn pockets - 5 feet wide, with a total of 11 feet required for both turn pockets and center striping.

Discussion

Offset intersection can be challenging for cyclists, who need to transition onto the busier cross-street in order to continue along the boulevard.

Bicycle Left-Turn Lane (Non-standard treatment)

Bicycle left-turn lanes allow the crossing to be completed in two phases. The bicyclist executes a right-hand turn onto the cross-street and then waits in a delineated left-turn lane if necessary. The bike turn pockets should be at least 5 feet wide, total of 11 feet for turn pockets and center striping.

Bicycle Left Turn Pocket (Non-standard treatment)

A bike-only left-turn pocket permits bicyclists to make left turns while restricting vehicle left turns. Signs should prohibit motorists from turning. Because of the restriction on vehicle left-turning movements, this treatment also acts as traffic diversion.

Guidance

- Alta and IBPI. Bicycle Boulevard Planning and Design Handbook.
- AASHTO Guide for the Development of Bicycle Facilities.

Level 4: Bicycle Boulevard Traffic Calming [\(7.B.6.f\)](#)

Design Summary

Traffic calming treatments reduce vehicle speeds to the point where they generally match cyclists' operating speeds, enabling motorists and cyclists to safely-reasonably co-exist on the same facility.



This bike-only left-turn pocket guides cyclists along a popular bike route

Discussion

Chicanes (Non-standard treatment)

Chicanes are a series of raised or delineated curb extensions on alternating sides of a street forming an S-shaped curb, which reduce vehicle speeds through narrowed travel lanes. Chicanes can also be achieved by establishing on-street parking on alternate sides of the street. These treatments are most effective on streets with narrower cross-sections.

Mini Traffic Circles

Mini traffic circles are raised or delineated islands placed at intersections, reducing vehicle speeds through tighter turning radii and narrowed vehicle travel lanes (see right). These devices can effectively slow vehicle traffic while facilitating all turning movements at an intersection. Mini traffic circles can also include a paved apron to accommodate the turning radii of larger vehicles like fire trucks or school buses.

Speed Humps

Shown right, speed humps are rounded raised areas of the pavement requiring approaching motor vehicles to reduce speed. These devices also discourage through vehicle travel on a street when a parallel route exists.

Speed humps should never be constructed so steep that they may cause a bicyclist to lose control of the bicycle or be distracted from traffic. In some cases, a gap could be provided, whereby a bicyclist could continue on the level roadway surface, while vehicles would slow down to cross the barrier.

Guidance

- Alta Planning + Design and IBPI. Bicycle Boulevard Planning and Design Handbook.
www.ibpi.usp.pdx.edu/guidebook.php
- City of Berkeley. (2000). Bicycle Boulevard Design Tools and Guidelines.
- AASHTO Guide for the Development of Bicycle Facilities.

Level 5: Bicycle Boulevard Traffic Diversion (7.B.6.g)

Design Summary

- Traffic diversion treatments maintain through-bicycle travel on a street while physically restricting through vehicle traffic.



Choker entrances prevent vehicular traffic from turning from a main street onto a traffic-calmed bicycle boulevard.



Traffic diverters prevent access to both directions of motor vehicle traffic.

- Traffic diversion is most effective when higher-order streets can sufficiently accommodate the diverted traffic associated with these treatments.

Discussion

Choker Entrances (Non-standard treatment)

Choker entrances are intersection curb extensions, or raised islands, allowing full bicycle passage while restricting vehicle access to and from a bicycle boulevard. When they approach a choker entrance at a cross-street, motorists on the bicycle boulevard must turn onto the cross-street while cyclists may continue forward. These devices can be designed to permit some vehicle turning movements from a cross-street onto the bicycle boulevard while restricting other movements.

Traffic Diverters (Non-standard treatment)

Similar to choker entrances, traffic diverters are raised features directing vehicle traffic off the bicycle boulevard while permitting through travel.

Advantages:

- Provides safe-a protected refuge in the median of the major street so that bicyclists only have to cross one direction of traffic at a time. Works well with signal-controlled traffic platoons coming from opposite directions.
- Provides traffic calming and safety benefits helps to avoid potential conflict by preventing left turns and/or through traffic from using the intersection.

Disadvantages:

- Potential motor vehicle impacts to major roadways, including lane narrowing, loss of some on-street parking and restricted turning movements.
- Crossing island may be difficult to maintain and may collect debris.

Guidance

- Alta Planning + Design and IBPI. Bicycle Boulevard Planning and Design Handbook. www.ibpi.usp.pdx.edu/guidebook.php
- City of Berkeley. (2000). Bicycle Boulevard Design Tools and Guidelines.
- AASHTO Guide for the Development of Bicycle Facilities.

6.7. Innovative Bike Lane Treatments

Bike Box (7.B.7.a)

Design Summary

Bike Box Dimensions:

- 14 feet deep to allow for bicycle positioning.

Signage: Appropriate signage as recommended by the MUTCD applies. Signage should be present to prohibit right turn on red and to indicate where the motorist must stop.

Discussion

A bike box is generally a right angle extension of a bike lane at the head of a signalized intersection. The bike box allows bicyclists to move to the front of the traffic queue on a red light and proceed first when that signal turns green. Motor vehicles must stop behind the white stop line at the rear of the bike box.

Bike boxes can be combined with dashed lines through the intersection for green light situations to remind right-turning motorists to be aware of bicyclists traveling straight, similar to the colored bike lane treatment described earlier. Bike boxes can be installed with striping only or with colored treatments to increase visibility. Use of coloration substantially increases costs of maintenance over uncolored (striping, bicycle symbol and text only) treatments.

Bike boxes should be located at signalized intersections only and right turns on red should be prohibited. Bike boxes should be used locations that have a large volume of cyclists and are often utilized in central areas where traffic is usually moving slowly. Reducing right turns on red improves **safety** ~~for~~ cyclists' **environment** and does not significantly impede motor vehicle travel.

On roadways with one travel lane in each direction, the bike box also facilitates left turning movements for cyclists.

Guidance

Evaluation of Innovative Bike-Box Application in Eugene, Oregon, Author: Hunter, W.W., 2000

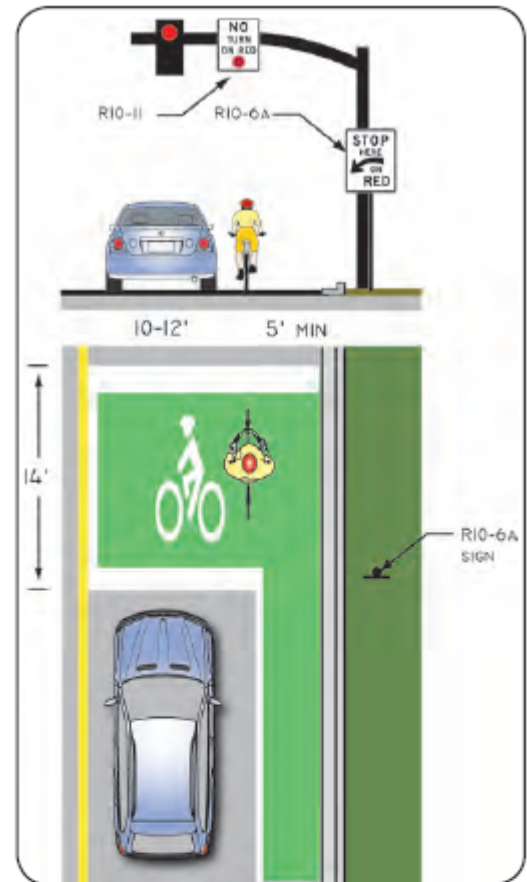

Recommended bike box design.



Bike boxes have been installed at several intersections in Portland, OR where right-turning motorists conflict with through bicyclists.

Shared Bicycle/Bus Lane (7.B.7.b)

Design Summary

Provide a standard width bike lane (minimum 4 feet) where possible.

Paint bicycle symbol or shared lane marking symbol to the left side of the bus lane to allow bicyclist to pass a bus that has turned in at a stop.

Discussion

The shared bus/bicycle lane should be used where width is available for a bus lane, but not a bus and bike lane. The dedicated lane attempts to reduce conflicts between bicyclists, buses and automobiles. Various cities have experimented with different designs and there is currently no evidence of one design being more effective than the others.

Shared bike/bus lanes can be appropriate in the following applications:

- On auto-congested streets and moderate or long bus headways.
- Moderate bus headways during peak hours.
- No reasonable alternative route.

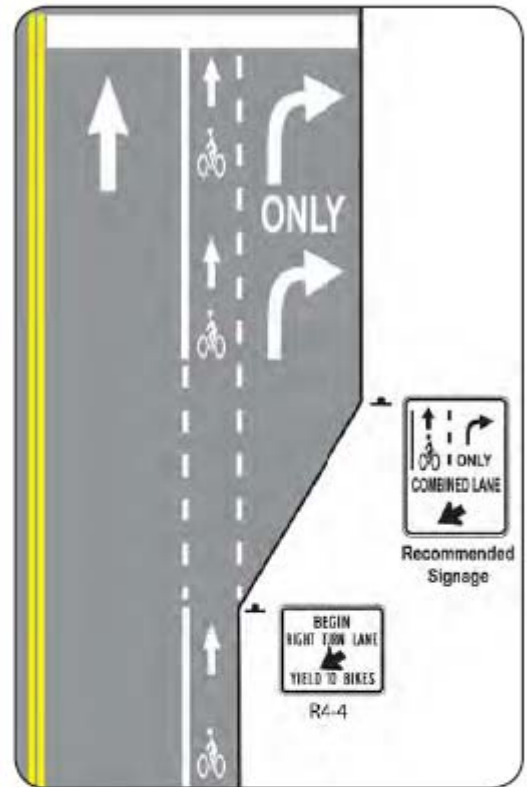

Recommended shared bike/right turn lane design.



Shared bike-right turn lanes require warning signage as well as pavement markings.

Shared Bike/Right Turn Lane (7.B.7.c)

Design Summary

Width:

- Shared turn lane – minimum 12 feet width.
- Bike lane pocket – minimum 4-5 feet preferred.

Discussion

This treatment is recommended at intersections lacking sufficient space to accommodate a standard bike lane and right turn lane. The shared bicycle/right turn lane places a standard-width bike lane on the left side of a dedicated right turn lane. A dashed strip delineates the space for bicyclists and motorists within the shared lane. This treatment includes signage advising motorists and bicyclists of proper positioning within the lane.

Case studies cited by the Pedestrian and Bicycle Information Center indicate that this treatment works best on streets with lower posted speeds (30 mph or less) and with lower traffic volumes (10,000 ADT or less).

Advantages:

- Aids in correct positioning of cyclists at intersections with a dedicated right turn lane without adequate space for a dedicated bike lane.
- Encourages motorists to yield to bicyclists when using the right turn lane.
- Reduces motor vehicle speed within the right turn lane.
- Disadvantages/potential hazards:
- May not be appropriate for high-speed arterials or intersections with long right turn lanes.
- May not be appropriate for intersections with large percentages of right-turning heavy vehicles.

Guidance

This treatment has coverage in the draft 2009 AASHTO *Guide for the Development of Bicycle Facilities*. It has been previously implemented in San Francisco, Calif., and Eugene, Ore.

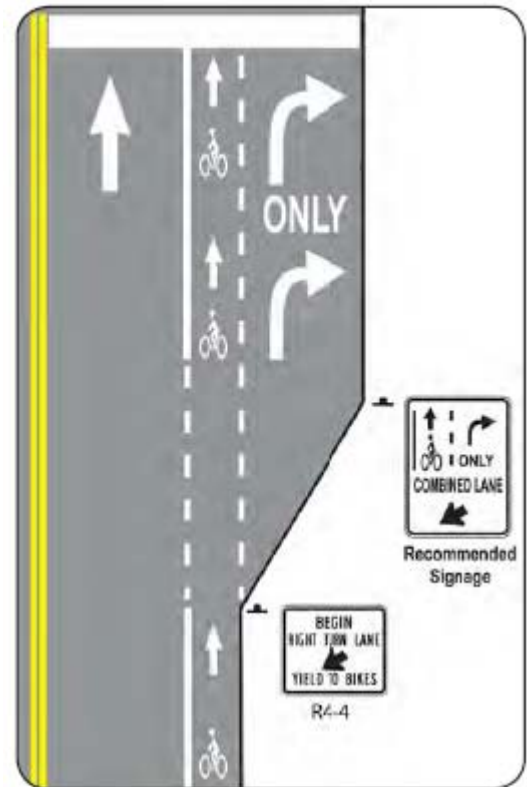

Recommended shared bike/right turn lane design.



Shared bike-right turn lanes require warning signage as well as pavement markings.

Colored Bike Lanes

Design Summary

- Bike lane pocket – minimum 4-5 feet preferred.
- Use colored pavement through entire merge area.
- Dashed lines can be used to indicate that automobiles are crossing the bike lane.
- Signage reminds drivers to yield to cyclists in the bike lane.

Discussion

Cyclists are especially vulnerable at locations where the volume of conflicting vehicle traffic is high and where the vehicle/bicycle conflict area is long. Some cities are using colored bike lanes to guide cyclists through major vehicle/bicycle conflict points. These conflict areas are locations where motorists and cyclists must cross each other's path (e.g., at intersections or merge areas). Colored bike lanes typically extend through the entire bicycle/vehicle conflict zone (e.g., through the entire intersection) or through the transition zone where motorists cross a bike lane to enter a dedicated right turn lane.

There are three colors commonly used in bike lanes: blue, green and red. Several cities initially used blue; however, this color is associated with amenities for handicapped drivers or pedestrians. Green is the color recommended for use in Albuquerque.

Advantages of colored bike lanes at conflict points:

- Draws attention to conflict areas
- Increases motorist yielding behavior
- Emphasizes expectation of bicyclists on the road.

Guidance

Although colored bike lanes are not an official standard at this time, they continue to be successfully used in cities, including Portland, Ore.; Philadelphia, Pa.; Cambridge, Mass.; Toronto, Ontario; Vancouver, B.C.; and Tempe, Ariz. This treatment typically includes signage alerting motorists of vehicle/ bicycle conflict points. Portland's Blue Bike Lane report found that significantly more motorists yielded to bicyclists and slowed or stopped before entering the conflict area after the application of the colored pavement.

Additional information in Portland Office of Transportation (1999). Portland's Blue Bike Lanes: Improved Safety through Enhanced Visibility. Available: www.portlandonline.com/shared/cfm/image.cfm?id=58842

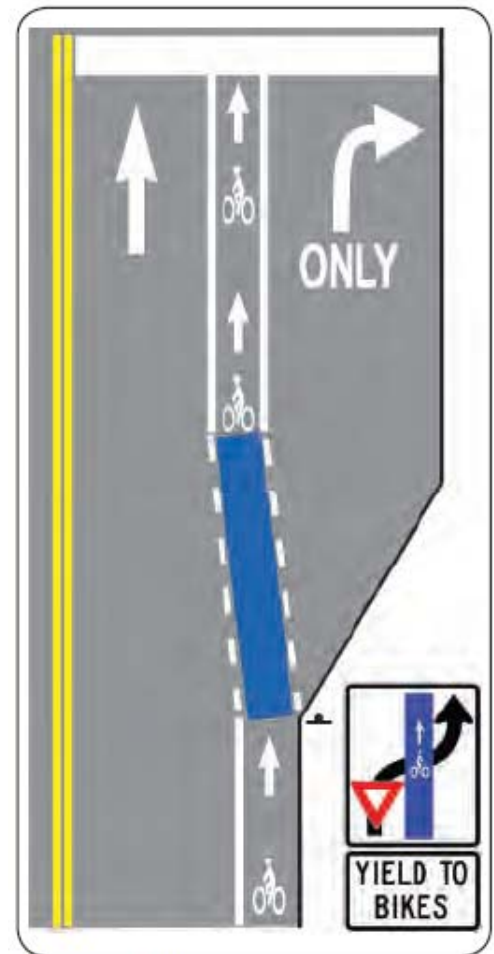

Recommended colored bike lane design.



Portland, OR has implemented colored bike lanes.

Buffered Bike Lanes

Design Summary

Guidelines for buffer width varies:

- 2.6 feet/80 centimeters (London and Brussels)
- 1.6-2.5 feet/50-75 centimeters (CROW Guide)
- 6 feet (Portland, Ore.)

Discussion

Bike lanes on high-volume or high-speed roadways can be dangerous or uncomfortable for cyclists, as automobiles pass or are parked too close to bicyclists. Buffered bike lanes are designed to increase the space between the bike lanes and the travel lane or parked cars.

This treatment is appropriate on bike lanes with high automobile traffic volumes and speed, bike lanes adjacent to parked cars and bike lanes with a high volume of truck or oversized vehicle traffic. Frequency of right turns by motor vehicles at major intersections should determine whether continuous or truncated buffer striping should be used approaching the intersection.

Advantages of buffered bike lanes:

- Provides cushion of space to mitigate friction with motor vehicles on streets with narrow bike lanes.
- Provides space for cyclists to pass one another without encroaching into the travel lane.
- Provides space for cyclists to avoid potential obstacles in the bike lanes, including drainage inlets, manholes, trash cans or debris.
- Parking side buffer provides cyclists with space to avoid the door zone of parked cars.
- Provides motorists greater shy distances from cyclists in the bike lane.

Disadvantages/potential hazards:

- Requires additional roadway space.
- Requires additional maintenance for the buffer striping.
- Frequency of parking turnover should be considered prior to installing buffered bike lanes.
- Increases the debris collection in the bike lane.

Guidance

This treatment is not currently present in any state or federal design standards. The City of Portland, Ore., included this treatment in the Bikeway Design Best Practices for the 2030 Bicycle Master Plan. Buffered bike lanes are currently also used in Brussels & Bruges, Belgium, Budapest, Hungary, London, U.K., Seattle, Wash., San Francisco, Calif., and New York, N.Y.

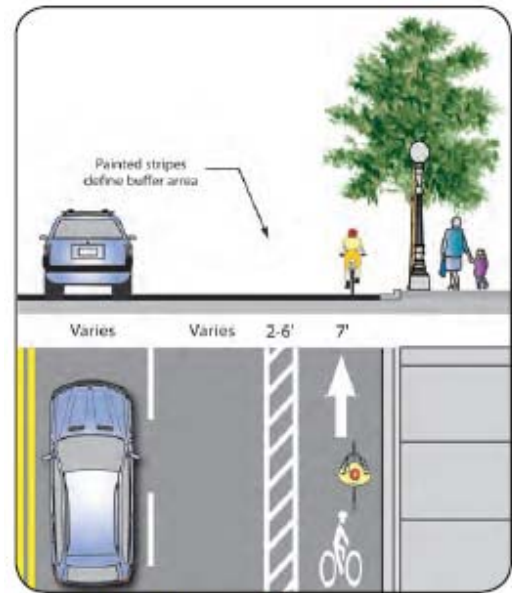

Recommended buffered bike lane design.



Buffered bike lanes protect cyclists from fast-moving traffic.

Floating Bike Lanes

Design Summary

It is important to provide adequate space to minimize the risk of “doorings” when parking is permitted. The bicycle symbol may be used curbside or sharrow markings in lieu of bike lane striping.

In San Francisco, parking is permitted during off-peak times: 9 a.m.-3 p.m. and 7 p.m. to 7 a.m.

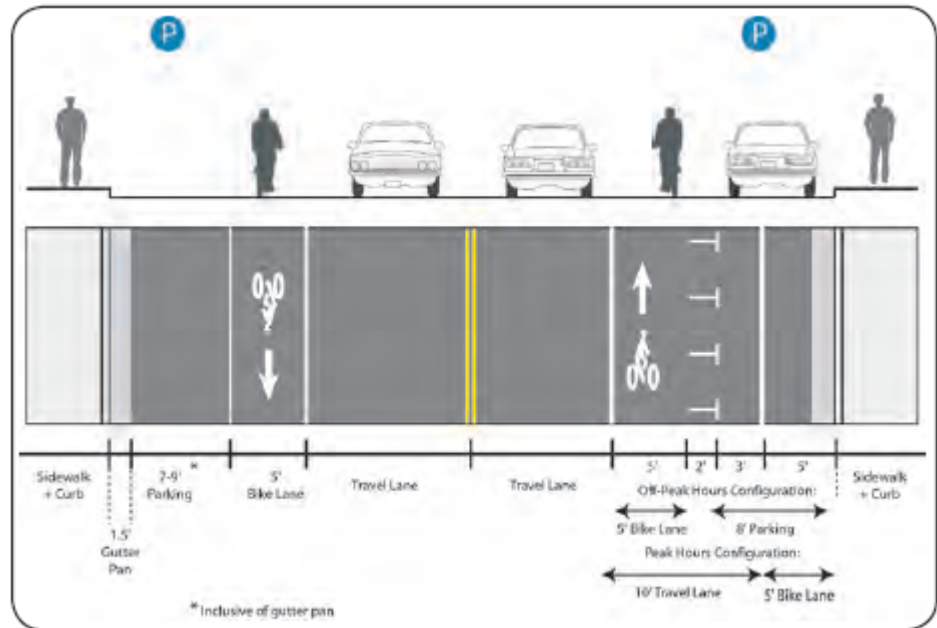

Recommended floating bike lane design.

Discussion

This treatment maintains the bicycle facility when an extra travel lane (for automobiles) is added during peak hours. A single lane can function as a parking lane or an exclusive bike lane. During peak hours, parking is not allowed and cyclists use a curbside bike lane. During off-peak hours, cyclists travel in the space between the motorized traffic lane and parked cars. This treatment can be used on primary bike routes during peak hours or on streets warranting bike lanes with high parking demand where there is insufficient space to provide both standard bike lane and parking.



Floating bike lane when parking is allowed on The Embaradero, San Francisco. Source: sfmta.org

Advantages of buffered bike lanes:

- Can accommodate bicycles at all times, even when parking is permitted.
- Provides bicycle facilities on streets with constrained rights-of-way.

Disadvantages/potential hazards

- Unorthodox design can be confusing to both cyclists and motorists.
- Enforcement is required.

Guidance

This treatment is not currently present in any state or federal design standards. The City of Portland, Ore., included this treatment in the Bikeway Design Best Practices for the 2030 Bicycle Master Plan. Floating bike lanes are currently used in San Francisco, Calif.

Contraflow Bike Lane

Design Summary

- The contraflow lane should be 5-6.5 feet and marked with a solid double yellow line and appropriate signage.
- Bike lane markings should be clearly visible to ensure that contraflow lane is exclusively for bicycles.
- Coloration should be considered on the bike lane.

Discussion

Contraflow bike lanes provide bi-directional bicycle access along a roadway that is one-way for automobile traffic. This treatment can provide direct access and connectivity for bicyclists, avoiding detours and reducing travel distances for cyclists.

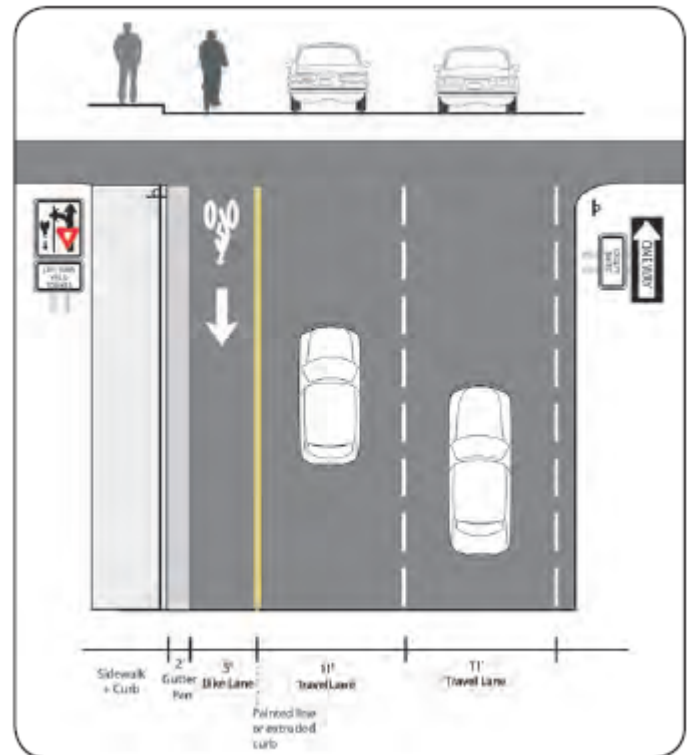

Recommended contraflow bike lane design.

Advantages of contraflow bike lanes:

- Provides direct access and connectivity for bicycles traveling in both directions.
- Influences motorist choice of routes without limiting bicycle traffic.
- Cyclists do not have to make detours as a result of one-way traffic.

Disadvantages/potential hazards:

- Parking should not be provided on the far side of the contraflow bike lane.
- Space requirements may require reallocation of roadway space from parking or travel lanes.
- The lane could be illegally used by motorists for loading or parking.
- Conversion from a two-way street requires elimination of one direction of automobile traffic
- Public outreach should be conducted prior to implementation of this treatment.



This contraflow bike lane in Portland, OR (left) provides a key connection along a narrow one-way street.

Guidance

This treatment is a federally-recognized design standard and present in some state Department of Transportation manuals, such as the Wisconsin Bicycle Facility Design Handbook. The City of Portland, Ore., included this treatment in the Bikeway Design Best Practices for the 2030 Bicycle Master Plan. Contraflow bike lanes are currently used in Olympia, Wash.; Seattle, Wash.; Madison, Wis.; Cambridge, Mass.; San Francisco, Calif.; and Portland, Ore.

8. Cycle Tracks

Design Summary

A cycle track is an exclusive bicycle facility that combines the user experience of a separated path with the on-street infrastructure of a conventional bike lane. Recommended cycle track width:

- 7 foot minimum to allow passing.

Discussion

Cycle tracks provide space that is intended to be exclusively or primarily for bicycles and are separated from vehicle travel lanes, parking lanes and sidewalks. Cycle tracks can be either one-way or two-way, on one or both sides of a street and are separated from vehicles and pedestrians by pavement markings or coloring, bollards, curbs/medians or a combination of these elements.

Cycle tracks provide:

- Increased comfort for bicyclists.
- Greater clarity about expected behaviour.
- Fewer conflicts between bicycles and parked cars as cyclists ride inside the parking lane.
- Space to reduce the danger of car dooring.

Danish research has shown that cycle tracks can increase bicycle ridership 18-20 percent, compared with the 5-7 percent increase associated with bike lanes.

However, disadvantages of cycle tracks include:

- Increased vulnerability at intersections.
- Regular street sweeping trucks cannot maintain the cycle track. Requires smaller sweepers.
- Conflicts with pedestrians and bus passengers can occur, particularly on cycle tracks that are undifferentiated from the sidewalk or that are between the sidewalk and a transit stop.

Cycle tracks should be placed along slower speed urban/suburban streets with long blocks and few driveways or mid-block access points for vehicles. Cycle tracks located on one-way streets will have fewer potential conflicts than those on two-way streets. A two-way cycle track is desirable when there are more destinations on one side of a street or if the cycle track will connect to a shared-use path or bicycle facility on one side of the street.

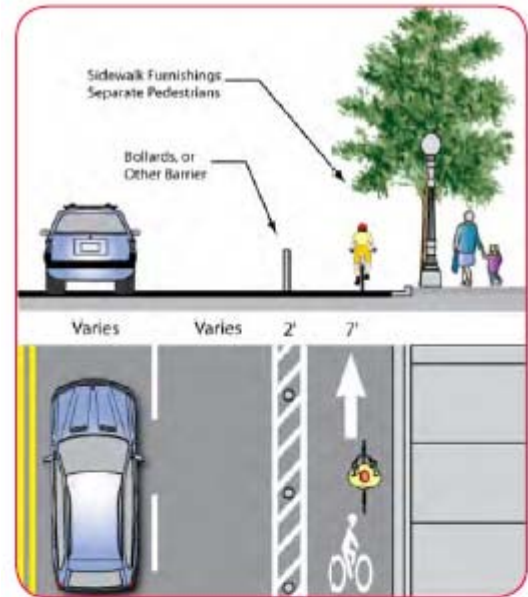

Recommended cycle track design without parking, using striping and flexible bollard separation.

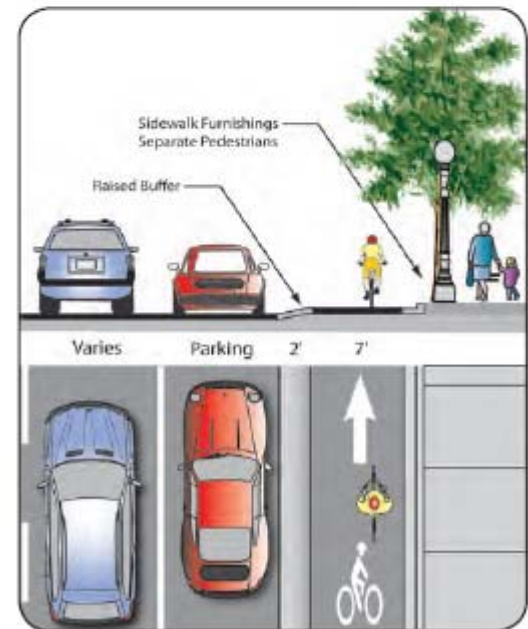

Recommended cycle track design with on-street parking.

Guidance

While only recently implemented in U.S. and Canadian cities, cycle tracks have been used in European countries for several decades. The cycle track design guidance was developed using best practices from European experience, as well as New York City, Montreal and Portland, Ore. Additional guidance: Cycle Tracks: Lessons Learned, Alta Planning + Design (2009).

www.altaplanning.com/App_Content/files/pres_stud_docs/Cycle%20Track%20lessons%20learned.pdf

Cycle Track Separation

Design Summary

Cycle tracks can be separated from vehicle traffic by a barrier or through grade-separation. Physical barriers can include bollards, parking, a planter strip, an extruded curb or parking. Cycle tracks using barrier separation typically share the same elevation as adjacent travel lanes. Pavement markings or other minimal separation should designate pedestrian space and discourage pedestrians from walking in the cycle track. Openings in the barrier or curb are needed at driveways or other access points. Grade-separated cycle tracks should incorporate a rolled curb, which allows cyclists to enter or leave the cycle track at will and enables motorists to cross the cycle track at intersections and crossings.

Discussion

Parking Placement

Where on-street parking exists, the cycle track should be placed between the parking and the sidewalk. The cycle track should be placed with a 2-foot buffer between parking and the sidewalk to minimize the hazard of dooring cyclists. Drainage inlets should be provided adjacent to the sidewalk curb to facilitate run-off. This technique is common in Copenhagen, as pictured right.

Channelization

Cycle tracks can be at street-level, provided that there is a physical separation. The curb creates the separated space, as well as preventing passengers from opening doors into the cycle track and discouraging pedestrians from walking on the facility.

Mountable Curb

Cycle tracks can be grade-separated from the roadway. The cycle track should be 2 or 3 inches above street-level, and the sidewalk should be an additional 2 to 3 inches above that.



Cycle track with a parking buffer, Copenhagen.



Cycle track with curb separation, Amsterdam.



Mountable curb, Copenhagen.



Cycle track with bollard separation, New York City.

Where cyclists may enter or leave the cycle track or where motorists cross at a driveway, the curb should be mountable with a small ramp, allowing cyclist turning movements.

Bollards and Pavement Markings

In addition to grade separation or channelization, the cycle track should have signage, pavement markings and/or different coloration or texture to indicate that the facility is provided for bicycle use. Signage, in addition to flexible bollards, can add to the physical separation of the facility, shown in this example from Melbourne, Australia.

Guidance

A buffer is not required of a cycle track wider than 7 feet, but is recommended where possible. The CROW Design Manual for Bicycle Traffic recommends that the buffer area inside built-up areas should be a minimum of 1.1 feet. If the buffer is a fence or other taller obstacle, a minimum of 2 feet shy distance is recommended on either side.

Cycle Track Intersection Treatments

Cycle tracks separate cyclists and motor vehicles to a greater degree than bike lanes. This leads to added comfort for cyclists on the cycle track, but it creates additional considerations at intersections that must be addressed. A right-turning motorist conflicting with cycle track users represents the most common conflict. Both roadway users have to expand their visual scanning to see potential conflicts.

Cycle Track Treatments at Driveways and Minor Street Crossings

Design Summary

Recommendations for increasing bicyclist visibility at driveways and minor street crossings:

- Maintain height level of cycle track, requiring automobiles to cross over.
- Remove parking 16 feet prior to the intersection.
- Use colored pavement markings through the conflict area.
- Place warning signage to identify the crossing (see page 5).

Discussion

At driveways and crossings of minor streets, the majority of traffic will continue through intersections, while a small



Cycle tracks should be continued through driveway crossings, improving visibility.



Colored pavement informs bicyclists and drivers of a potential conflict area.



Bicycle markings at a driveway crossing.

number of automobiles will cross the cycle track. At these locations, cyclist visibility is important, as a buffer of parked cars or vegetation can hide a cyclist traveling in the cycle track.

Cyclists should not be expected to stop at these minor intersections if the major street does not stop, and markings and signage should be used to indicate that drivers should watch for cyclists.

Access management should be used to reduce the number of crossings of driveways on a cycle track.

Guidance

See the CROW Design Manual for Bicycle Traffic or Cycle Tracks: Lessons Learned, Alta Planning + Design (2009) for additional guidance.

www.altaplanning.com/App_Content/files/pres_stud_docs/Cycle%20Track%20lessons%20learned.pdf

Cycle Track Treatments at Major Street Crossings

Design Summary

Recommendations for increasing bicyclist visibility at major street crossings:

- Stripe stop line 16 feet back from the intersection.
- Remove parking 16 feet prior to the intersection.
- Drop cycle track to bike lane 16 feet back from intersection.
- Use bike box treatments to move cyclists in front of traffic (see page 2).
- Use colored pavement markings through the conflict area.

Discussion

Protected phases at signals or scramble signals separate automobile turning movements from conflicting through-bicycle movements. Bicycle signal heads ensure that all users know which signals to follow. Demand-only bicycle signals can require user actuation and reduce vehicle delay by



Cycle track dropping to bike lane before an intersection.



Crossings should separate space for bicyclists and pedestrians.



At this unsignalized right turn, the cycle track has dropped to a bike lane with blue coloration and pavement markings through the conflict area.



Bike-specific signals are small and placed on the near-side of traffic.

preventing an empty signal phase from regularly occurring.

Advanced signal phases can be set to provide cycle track users an advanced green phase. This places cyclists in front of traffic and allows them to make their turning movements without merging into traffic.

An advanced warning allows bicyclists to prepare to move forward through the intersection. This warning can be accomplished through a pre-green interval, a yellow warning display two seconds before the green or a bicycle countdown signal.

Guidance

The CROW guide states that if the speed of the main street is 45 mph or less, the cycle track should turn inwards prior to crossing a side street. This is to improve visibility of cyclists to motorists in the main road turning right. If the speed is greater, the cycle track should bend away from the main road at intersections so that vehicles leaving the main road can stack up on the cross street between the cycle track and the main road. Signage should also warn motorists of the crossing.

Left Turn Movements

Design Summary

Left turn opportunities for cyclists can be provided in the following ways:

- Copenhagen lefts are a two-stage crossing, which include a turning and waiting area at the far side of the first intersection.
- Box lefts are pockets where bicyclists can move to the right hand side of the cycle track and wait for a crossing signal. This treatment can result in the cyclist being on the wrong side of the street in a standard four-way intersection.
- Scramble signals.

Discussion

Bicyclists are often not allowed to make left-turn movements from the cycle track can be physically barred from moving into



Left-turn from a cycle track on the right via bicycle-signal phase in Stockholm, Sweden.



"Copenhagen Left" application.



"Box left" turn in Troisdorf, Germany.

the roadway by the cycle track barrier.

The “Copenhagen Left” (also known as the “Melbourne Left,” the “jug-handle turn” and the “two-stage left”) is a way of enabling a safe left-turn movement by bicyclists in a cycle track. Bicyclists approaching an intersection can make a right into the intersecting street from the cycle track to position themselves in front of cars. Bicyclists can go straight across the road they were on during next signal phase. All movements in this process are guided by separate traffic signals. Motorists are not allowed to make right turns on red signals. In addition, motorists have an exclusive left-turn phase in order to make their movements distinct from the bicyclists’.

Guidance

See the CROW Design Manual for Bicycle Traffic or Cycle Tracks: Lessons Learned, Alta Planning + Design (2009) for additional guidance.

www.altaplanning.com/App_Content/files/pres_stud_docs/Cycle%20Track%20lessons%20learned.pdf

Two-Way Cycle Tracks

Design Summary

- 12 foot minimum to allow passing. Fourteen-foot recommended (New York City).
- Striped center line to separate traffic.
- Pavement markings should indicate direction.

Discussion

A two-way cycle track is desirable when more destinations are on one side of a street (therefore preventing additional crossings) if the facility connects to a path or other bicycle facility on one side of the street or if there is not enough room for a cycle track on both sides of the road.

Bidirectional cycle tracks are acceptable in the following situations:

- On a street with few intersections or without access on one side (e.g., along a waterway or rail line).
- On a one-way street with fewer than one intersection every 100 feet.
- On two-way streets where left-hand turns are prohibited and with a limited number of intersections and driveway entrances.



Two-way cycle track with dividing line.



Directional markings on cycle track.



Pavement markings indicate travel direction at a minor roadway crossing on this cycle track in Paris, France.

Parking should be banned along the street with the bike path to ensure adequate stopping sight distances for motorists crossing the path.

Two-way cycle tracks have many similar design characteristics as one-way tracks: they are physically divided from cars and pedestrians and require similar amenities at driveway and side-street crossings.

Two-way cycle tracks require a higher level of control at intersections to allow for a variety of turning movements. These movements should be guided by a separated signal for bicycles and for motor vehicles. Transitions onto bidirectional cycle tracks should be simple and easy to use to deter bicyclists from continuing to ride against the flow of traffic.

In addition, bicyclists riding against roadway traffic in two-way cycle tracks may surprise pedestrians and drivers at intersections.

Guidance

Vélo Québec Technical Handbook of Bikeway Design. (2003), CROW Design Manual for Bicycle Traffic and Alta Planning + Design Cycle Tracks: Lessons Learned, (2009).

CD. Trail Design

1. Background Information

In 1981, the American Association of State Highway and Transportation Officials (AASHTO) first attempted to create a comprehensive set of guidelines for accommodating bicyclists in various riding environments. Although it was not intended to set forth strict standards, the AASHTO Guide for the Development of Bicycle Facilities (revised in 1991, 1999, and the current 2012 fourth edition) has been the predominant source of information in this area although no enforceable Federal standards exist.

While most states have deferred to AASHTO's guidelines as de-facto design standards since 1981, some state and local governments are leading the way in the production of their own standards and guidelines in order to address local issues and meet the current needs of pedestrians, bicyclists, equestrians, and other user groups. In 1992, the U.S. Department of Transportation and the Federal Highway Administration conducted a national bicycling and walking survey entitled Case Study No. 24, Current Planning Guidelines and Design Standards Being Used by State and Local Agencies for Bicycle and Pedestrian Facilities. That study was followed in 1999 by a similar, but broader effort entitled Designing Sidewalks and Trails, Part 1: Review of Existing Guidelines and Practices. By compiling and listing a number of examples of state and local guidelines, these documents identified models to which other communities could refer when developing their own bicycle and pedestrian plans, as guides to the state of the practice. (Part 2 of the 1999 FHWA study summarizes the earlier findings in a "best practices" guide, described more fully below.)

Until recently, bicycle-related [safety issues-protection measures](#) (such as appropriate widths, turning radii, sight distances, and avoiding conflicts with vehicular traffic) have been the dominant trail design

concerns. While these remain vital concerns, the presence of accepted standards such as the AASHTO guidelines have led to a shift in focus toward providing more “inclusive” and accessible outdoor recreational settings, especially in the urban environment. Rather than focusing solely on the cyclist and/or pedestrian, our collective awareness has been broadened to include all types of users, including children, parents with strollers, equestrians, people in wheelchairs, vision impairments, and those with other impairments or physical challenges. It is relatively easy to design for one or two user groups; however, it is extremely challenging to design multi-use trails that will be perfect for every user group.

ADA Guidelines (7.C.1.a)

The Americans with Disabilities Act of 1990 (ADA) prohibits discrimination and ensures equal opportunity for persons with disabilities in employment, State and local government services, public accommodations, commercial facilities, and transportation. It also mandates the establishment of TDD/telephone relay services. The current text of the ADA includes changes made by the ADA Amendments Act of 2008 (P.L. 110-325), which became effective on January 1, 2009 and is now accompanied by the 2010 ADA Standards for Accessible Design. Together they provide national accessibility regulations for buildings and related urban environments. However, when designing outdoor recreational facilities or multi-use trails (with the exception of facilities built on Federal Land), the application of strict ADA standards often proves impractical and currently lacks any Federal ruling or legal requirement. There is practical design and smart practices that can and should be followed when building multi-use trail and trailhead facilities. These will be followed until the Federal government adopts a ruling for requirements that shall be followed. The following is some history on how practical design and smart practice came to be.

In 1993, the nonprofit organization Project Play and Learning in Adaptable Environments, Inc., (PLAE), in partnership with the USDA Forest Service and a number of other agencies and organizations, took the initiative to develop guidelines and published *Universal Access to Outdoor Recreation: A Design Guide*. By acknowledging a desire for various levels of recreational challenge and related facility development in settings ranging from highly-developed urban to primitive, natural landscapes, this book pioneered the way for designers to address the needs of people of all abilities in outdoor recreation and provides a universal approach to outdoor design in the spirit of ADA regulations. However, as comprehensive as it is, the PLAE design guide does not yet enjoy the support of law, such as ADAAG.

To address this, the U.S. Architectural and Transportation Barriers Compliance Board (a.k.a. the “Access Board” -- the agency which administers and develops accessibility design guidelines) formed the Recreation Access Advisory Committee (RAAC) to study the issues and develop federal standards for outdoor recreational facilities. Based in part on the research and recommendations of the PLAE partnership in *Universal Access to Outdoor Recreation*, the RAAC published draft *Recommendations for Accessibility Guidelines: Recreational Facilities and Outdoor Developed Areas* in 1994 but could not reach consensus on many issues. Public comment also demonstrated a lack of consensus, especially

regarding trails accessibility. In 1997 the Access Board created the Outdoor Developed Areas Regulatory Negotiation Committee (RNC), with representation by people with disabilities, state, federal and local land management agencies, trails groups, designers, and owners/operators of various “outdoor developed areas.” After careful examination of the previous work done by RAAC, and the solicitation of input from the public, a final report was submitted by the RNC to the Access Board in September of 1999 [2013](http://www.access-board.gov/guidelines-and-standards/recreation-facilities/outdoor-developed-areas/final-guidelines-for-outdoor-developed-areas) (available at <http://www.access-board.gov/guidelines-and-standards/recreation-facilities/outdoor-developed-areas/final-guidelines-for-outdoor-developed-areas>~~http://www.access-board.gov/outdoor/outdoor-rec-rept.htm~~). The report gives recommendations on accessibility issues related to outdoor recreation access routes, beach access, picnic elements, and camping facilities.

The 2000 Census shows that 20% or approximately 54 million U.S. Citizens over the age of 15 have a disability. Also, 17 million Americans have serious hearing disabilities (2000 Census). There are three times more people with severe vision impairments than there are wheelchair users and information is a barrier for people with vision disabilities.

The newest and most comprehensive guidelines that can and should be used when designing multi-use trails is called Public Rights of Way Accessibility Guidelines (PROWAG). These guidelines were originally intended to supplement the ADAAG to provide standards specific to public rights-of-way. Applicable to new construction and alterations of existing facilities within the public right-of-way excluding shared-use paths or multi-use trails. As an enforceable standard, PROWAG provides the best guidelines for multi-use trail design and should be followed until there is specific guidelines enforceable for multi-use trails. When designing multi-use trails for ADA, the two main barriers of people with disabilities should be remembered. Movement and information are two major barriers for people with disabilities. People with mobility disabilities may have limited agility, speed, endurance and may benefit from designers implementing firm level surfaces, curb ramps where needed, and limited cross slopes. People with vision impairments from complete blindness to partial vision tend to benefit from sounds, textures, and contrasts such as audible/vibrotactile crossing information, tactile indication of boundary between pedestrian and vehicular roadways, clearly defined pathways, and high color contrasts. People with hearing disabilities rely on vision and benefit from good sight lines for assessing street crossing conditions, information in the visual, and information in a visual or vibrotactile format. Persons with cognitive disabilities have different processing and decision-making skills and benefit from straightforward, and direct environments, uncomplicated street crossings, and easy to understand symbols. Therefore, the design of multi-use trails should try and accommodate a broad spectrum of users and enable users to travel independently as much as possible.

FHWA Best Practices Guidelines (7.C.1.b)

In 2001 the FHWA issued the latest in its series of technical guides intended to help designers at the state level more easily integrate bicycle and pedestrian projects into mainstream transportation projects. Designing Sidewalks and Trails for Access, Part 2: Best Practices Design Guide followed their earlier

compendium of existing guidelines and practices (described above). According to the transmittal letter which accompanied the initial distribution of the Best Practices Design Guide, “its aim was to develop tools to help the FHWA, and State and local governments meet their responsibilities under Title II [of the Americans with Disabilities Act of 1990] and Section 504 [of the Rehabilitation Act of 1973], while reducing their vulnerability to complaints filed under the ADA. The guide reflects recognized “best practices” in effect at the time of publication, and also incorporates recommendations from the Access Board’s 1999 final report from the Regulatory Negotiation Committee on Accessibility Guidelines for Outdoor Developed Area (described above).

State and Local Efforts (7.C.1.c)

The City of Albuquerque’s efforts to address trail implementation date back to 1973, when an advisory committee began research for The Bikeway Study, which was published the following year. That document marked Albuquerque’s first bicycle network plan, which evolved into the Long Range Bikeway System maps currently published by Mid-Region (formerly Middle Rio Grande) Council of Governments (MRCOG). In the early ‘80s, the Albuquerque/Bernalillo County Comprehensive Plan reaffirmed the City’s dedication to implementing a multi-purpose trails network.

Other local documents created in the mid-1980s to the early ‘90s began to address trail design issues specific to Albuquerque. The 1986 Facility Plan for Arroyos, for example, promotes the use of the city’s numerous drainage features for urban recreational purposes. A number of Arroyo Corridor Plans further carry out the multi-use trail goals stated in the Facility Plan. The Bear Canyon Arroyo Corridor Plan, San Antonio Arroyo Corridor Plan, Amole Arroyo Corridor Plan, and Pajarito Arroyo Corridor Plan have been adopted by the City and contain varying levels of design guidelines for implementing specific types of trails. Several other corridors, including the City’s two largest arroyos, the Calabacillas and Tijeras, have been the subjects of similar studies, which have not yet been adopted.

In 1989, the City Council adopted Bill No. 0-133 establishing a Greater Albuquerque Recreational Trails Committee (GARTC), which serves as the off-road counterpart to the Greater Albuquerque Bicycling Advisory Committee (GABAC), providing a voice for the trail-user and cycling communities in City government. In conjunction with the City’s Planning Department, GARTC began research for a “Master Recreational Trails Plan” shortly after its formation. This process resulted in the 1993 Trails & Bikeways Facility Plan, which represents the city’s most comprehensive trails planning document to date (plan maps updated in 1996).

In 1996, the New Mexico State Highway and Transportation Department (NMSHTD – now NMDOT) produced the first state-wide New Mexico Bicycle-Pedestrian-Equestrian (BPE) Transportation Plan. Developed partially in fulfillment of federal mandates under the Intermodal Surface Transportation Efficiency Act of 1991 (ISTEA), the plan provides general guidance in the development of bikeways, walkways, and equestrian trails. Three appendices include some design standards, applicable state laws,

and trail-related signing and striping excerpts from the Manual on Uniform Traffic Control Devices (MUTCD). The recommendations in the plan are “loosely categorized” according to an emerging national convention called the “4-E” approach, which emphasizes the four functional areas of engineering, education, enforcement, and encouragement in promoting and implementing successful BPE programs. The state plan was revised in 1999, 2001, and 2003. Currently, the NMDOT has begun a comprehensive and collaborative process to develop a 2040 Statewide Long-Range Multimodal Transportation Plan (SLRP). The plan will provide a vision for how New Mexico’s transportation system can support the well-being of our residents and visitors now and in the future.

Current Directions (7.C.1.d)

The various local documents concerning Albuquerque trails have provided the first stages in trail design guidance based upon needs of individual user groups. However, they fall short in providing adequate guidelines for implementing a multi-purpose network that will accommodate all potential users. Many were oriented primarily toward bicycles, while those which addressed multiple users tended to focus on separate single-use facilities.

In the greater Albuquerque area, as is true throughout the nation, finding solutions to the wants and needs of multiple user groups is increasingly challenging. It is simply not feasible in most cases to provide separate facilities for each of the various use types. Acquiring sufficient right-of-way to provide adequate widths and safe-necessary separations for multiple, parallel trails is cost prohibitive, at best, and is often not even possible within developed portions of the city. The City of Albuquerque has adopted the strategy of accommodating multiple user groups with the design and construction of multi-use trails.

Designing for Multiple-Use (7.C.1.e)

The concept of combining user groups on single trail facilities is not without its difficulties. Multi-purpose trail design is faced with the challenge of allowing for the freedom of choice essential to a satisfactory outdoor recreation experience, on one hand, while at the same time minimizing conflicts between different trail users. In order for multi-use trails to function effectively, the various user groups need to be cognizant and respectful of the needs of other users. Public education is an important element in reducing conflicts often associated with multi-use trails.

A number of studies have been undertaken at various levels to try to understand the underlying causes of trail conflicts. In 1994 the Federal Highway Administration and the National Recreational Trails Advisory Committee sought to summarize this information and “establish a baseline of the current state of knowledge and practice and to serve as a guide for trail managers and researchers.” Their resulting report, *Conflict on Multiple-Use Trails*, offers a useful summary of possible management strategies that adhere to the “minimum tool rule,” which advocates using the least intrusive measures possible. Some of their suggestions include:

- Build trails wide enough to accommodate expected levels of use
- Provide adequate trail mileage and a variety of trail opportunities
- Provide appropriate signage and/or educational material
- Design in adequate sight distances and provide pullout areas
- Paint a yellow centerstripe and two white sidestripes on all multi-purpose trails within the City of Albuquerque Right of Way.
- Have an effective maintenance program appropriate to trail type and use.

Trail Difficulty Rating System

In most instances, individuals intentionally choose a specific environmental setting when exploring the outdoors. These choices are made with distinct expectations for recreational experiences, especially with regard to the level of accessibility of a given area or facility. Because of the close relationship between the expectation and the resultant outdoor experience, successful design and management strategies should include an understanding of this cause and effect. A key to this success lies in the provision of adequate information to enable trail users to make informed decisions about a given facility.

Trail users can more easily gauge the level of effort required for a given segment of trail through the implementation of a difficulty rating system. Although no national standard format has yet been established, five key attributes have emerged for assessing the navigability of a trail facility. Referred to as the Universal Trail Assessment Process (UTAP), this system quantifies each of the following elements:

- Grade/Running Slope/Inclination (average and maximum)
- Cross Slope (average and maximum)
- Trail Width (average and minimum)
- Surface Type/Condition (firmness)
- Obstacles (type and magnitude)

Both PLAE and RAAC recommend the additional measure of summarizing the above information into a rating hierarchy similar to ski run designations – Easy, Moderate, Difficult, and Most Difficult, with accompanying “Universal Design” symbols which graphically reinforce the text designation (discussed further under “Signage” later in this report). However, it should be emphasized that without the UTAP attributes, the simple designation of “Easy” or “Moderate” becomes very subjective and may not provide adequate information to some trail users to assess their ability to negotiate a particular facility.

Of course, other factors also influence ease of use, including overall length of a given trail facility, as well as the relative distances between specific facilities, use areas, and access points. Awareness of those factors is key to determining a trail user’s ability to complete a trail segment, given their own abilities or the amount of time available. And while more difficult to quantify in terms of the above system, these factors can be conveyed via trail maps and/or mileage signs.

Local Applicability (7.C.1.f)

Trail design and construction have increased dramatically in Albuquerque since 1991 and the passage of the first federal Intermodal Surface Transportation Enhancement Act (ISTEA), which set aside unprecedented levels of funding for alternative transportation facilities, including trails. And, given the passage of its successor bills, TEA-21 and the current SAFETEA-LU (2005-2009), this trend is not likely to end soon. In short, trail planners are not waiting for a uniform federal standard for trail development. However, in the absence of any comprehensive local standards, there is a great deal of variability in the configuration of those facilities. Until the Access Board issues its “final rule” and codifies it as law, an interim standard is needed to guide trail development in the greater Albuquerque area.

Since the underlying goal is to make Albuquerque’s trails accessible to as many people as possible, regardless of ability, the trail community and the larger transportation system as a whole would best be served by striving for the highest level of accessibility that can reasonably be attained within the realms of the underlying natural landscape and physical geography. Therefore, to the extent practicable, paved trails within the City’s jurisdiction should be in substantial compliance with the current PROWAG as stated in the sections above. At such time as new federal regulations for shared-use paths are ruled and enacted, the ADAAG and PROWAG standards should still take precedence. Any trails within Federally owned and managed lands are subject to the Access board’s ruling for outdoor developed areas.

2. General Trail Information

While not intending to stifle creativity or variation among projects, this document is intended to provide a basic set of design guidelines which sets forth minimum acceptable parameters for various types of trail facilities constructed within the greater Albuquerque area. The guidelines are organized into a number of categories, each of which may have up to three levels of information: **Design Standards**, which represent minimum required design criteria; **Design Considerations & Guidelines** provide background information and issues that may influence facility design; and **Design Guidance** offers suggested criteria or other information which may guide the design process.

The AASHTO Guide for the Development of Bicycle Facilities (2012 edition) has an extensive section of design guidelines for Shared Use Paths, covering the following categories:

- Separation between Shared Use Paths and Roadways

- Width and Clearance
- Design Speed
- Horizontal Alignment
- Grade
- Sight Distance
- Path-Roadway Intersections
- Signing and Marking
- Other issues, such as Lighting; Restriction of Motor Vehicles; Railroad Crossings; etc.

Rather than duplicating that information here, this document will instead focus on issues and criteria specific to Albuquerque’s multi-use trail system. The remainder of the material from the AASHTO Guide is incorporated herein by reference. In the event of a conflict with this or future versions of the AASHTO Guide, the more stringent criteria will apply.

The Federal Highway Administration’s Manual on Uniform Traffic Control Devices (MUTCD), Part 9: Traffic Control for Bicycles, is the accepted reference for most matters relating to signage, signalization, and striping of bicycle trails. The MUTCD offers three levels of information: Standards, which should be followed; Guidance, which is recommended, but not required; and Options, which are permitted, and may or may not be followed, at the discretion of the local authority. The guidelines presented in the MUTCD should be followed in the design of Albuquerque’s multi-use trails.

Shared-use paths, multi-use trails, or simply “trails,” provide a desirable facility for cyclists, pedestrians, equestrians, and other trail users. They allow for travel and recreational use that is separated from traffic. Multi-use trails should generally provide new travel opportunities while accommodating all types of trail users.

The Albuquerque Development Process Manual defines a shared-use path/trail as, “A shared use path is a bikeway physically separated from motorized vehicle traffic by an open space or barrier and constructed within the street right-of-way or within an independent right-of-way including shared-use rights-of-way or utility or drainage easements.” It is recommended to change this definition to “a shared-use path designed primarily for use by cyclists, pedestrians (including people with disabilities), for transportation and recreation purposes. Shared-use paths are physically separated from motor



Shared-use paths (also referred to as “trails” and “multi-use paths”) are often viewed as recreational facilities, but they are also important corridors for utilitarian trips.

vehicle traffic by an open space or barrier and are either within the public street right-of-way or within an independent (private) right-of-way.”

Trail Types (7.C.2.a)

Albuquerque’s multi-use trails can be grouped into two broad categories: paved and unpaved multi-use trails. **Paved trails** are intended to accommodate all types of non-motorized users that include but not limited to bicycles (and other types of cycles), in-line skates and ski trainers, all types of skateboards, strollers, wheelchairs, equestrians, and many types of pedestrians preferring a hard, all-weather surface. **Unpaved trails** typically accommodate but are not limited to (unless posted and signed) equestrians, mountain bikers, hikers, and pedestrians preferring a soft walking surface (stabilized unpaved trails may also be suitable for wheelchair users depending on their ability). In any given corridor, these two basic trail types may be categorized in one of three ways:

- Single Track, Limited Use – although this runs counter to the concept of “multiple-use,” there may be instances where only single use types are allowed or, more frequently, certain uses may be prohibited in order to minimize potential conflicts or impacts. This situation would most likely occur in specific management areas such as Wilderness areas or designated Open Space facilities, such as the Pino Trail at Elena Gallegos. [Site specific signage will define the appropriate usage of trails in Open Space. The Open Space Division is responsible for defining appropriate uses based on topography, environmental conditions, and to avoid potential user conflicts.](#)
- Single Track, Multiple Use – either of the trail types (paved or unpaved) within a corridor by itself, but open to any non-motorized users. This category comprises the vast majority of Albuquerque trails.
- Multiple Track, Multiple Use -- in some cases, it may be possible and appropriate to provide parallel hard and soft-surfaced trails within the same corridor. Some separation between the two types is desirable.

Trail Location (7.C.2.b)

As noted in the AASHTO Guide, multi-use trails (“shared use paths”) should serve as an off-road transportation system which augments a community’s roadway network. “Shared-use paths should not be used to preclude on-road bicycle facilities, but rather to supplement a system of on-road bike lanes, wide outside lanes, paved shoulders, and bike routes” [AASHTO, 1999, p.33]. This is because even though off-street facilities may parallel a roadway, the presence of other, usually slower, users may make the trail a less efficient (and in fact more dangerous) route for commuters or other “serious” cyclists. Multi-use trails may be located in separate, designated corridors (purchased, donated, negotiated, or dedicated during the development process), or shared rights-of-way, utilizing corridors along arroyos, power lines, and even roadways (assuming minimal driveway and other intersection crossings).

All trails built within the City of Albuquerque right-of-way should be built to the guidelines proposed in this design manual whether it is a private developer building out a section of road or an entire

subdivision. If a developer constructs a trail and it is intended to be maintained by a Homeowner’s Association, Neighborhood Association, or any means other than a public governmental agency such as the City of Albuquerque, the trail shall be built to the standards of this design manual in consultation with the Parks and Recreation Department’s Trails Planner or other City official. If a trail is to be built within a private right-of-way, it is not required to be built to City standards or specifications however, it is highly recommended. Trails built to City standards ensure longevity and high quality resulting in less maintenance costs to the entity maintaining the trail. Trails built within a private right-of-way shall never be maintained by the City of Albuquerque or other governmental or quasi-governmental entity unless there is a trail maintenance agreement or other legal agreement that is signed and accepted by the City or other agency.

The City of Albuquerque may require a “*trail maintenance agreement*” when a trail is built within the City right-of-way to ensure there is sufficient documentation of who will retain maintenance responsibility after the project is constructed. The City requires developers to help build out trail sections when they go through the development process when the trail is a proposed link on the Bikeways and Trails Facility Plan map. All trails within the public right-of-way are open to use by the public. Trails built within an independent or private right-of-way do not have to be open to the public but can be.

Design Considerations & Guidelines

The maps that are associated with the Bikeways and Trails Facility Plan show locations of many proposed facilities as well as existing facilities. The updated map is based on the Mid-Region Council of Governments (MRCOG) Long Range Bikeway System map, as well as many Sector and Facility Plans prepared by or for the City of Albuquerque. Specific locations should be coordinated with the City’s Trails Planner when developments are going through the design, planning, and construction process.

3. Trail Design Criteria

Trail Cross Section for typical paved multi-use trail (7.C.3.a)

Design Standards

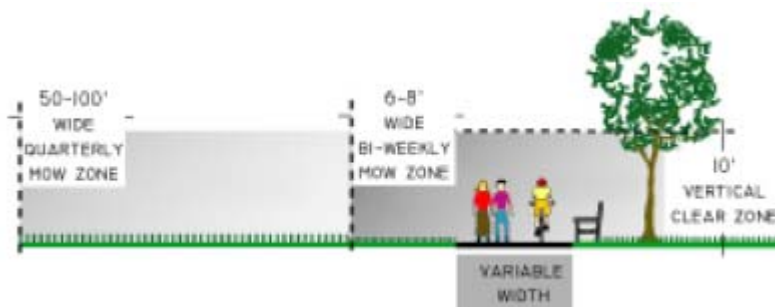

Width (same as the DPM standards)

- 10 feet is the minimum allowed for a two-way shared-use path (trails less than 10 feet wide need an exception by the City and may need a separate legal “trail maintenance agreement”).

- 12 feet or greater is recommended for high-use areas and regional corridors, or in heavy use situations with high concentrations of multiple users, such as joggers, bicyclists, skaters, equestrians, and pedestrians.

Lateral Clearance

- A 2 foot or greater compacted shoulder on both sides.
- 3' or more from walls, fences, posts, signs, and other structures.

Overhead Clearance

- Clearance to overhead obstructions should be a minimum of 10 feet.

Design Speed

- The maximum design speed for bike paths is 18-20 mph. Speed bumps or other surface irregularities should never be used to slow bicycles.

Grade

- The recommended running grade is 5% or less. Steeper grades can be tolerated for shorter distances. See the table regarding grades. The cross slope shall be no greater than 2%. It is recommended cross slope is designed at 1.5%.

Design Considerations & Guidelines

Trails should be constructed according to this design manual. Further guidance can be found in the books and publications listed in the beginning of the manual. Constructing trails may have limitations in regards to PROWAG or any ADA document issued in the future for. Prohibitive impacts include harm to significant cultural or natural resources, a significant change in the intended purpose of the trail, requirements of construction methods that are against federal, state or local regulations or presence of terrain characteristics that prevent compliance.

Surfacing (7.C.3.b)

~~Although multi-use trails today are not required to meet any ADA guidelines the following is a smart practice to follow:~~ According to the ADA, an accessible surface must be “stable, firm, and slip-resistant” [28 CFR Part 36, Appendix A, Section 4.5.1; 1994, p. 513]. Trail or path surfaces which meet these criteria can accommodate bicyclists, in-line skaters, individuals using wheelchairs, and other trail users who need or prefer the security of a firm surface. Any pavement design should be prepared or approved by a geotechnical engineer, based on site-specific soil conditions. Nonetheless, some general design parameters apply specifically to trail construction, as outlined below.

Concrete

In general, concrete trail surfacing should follow The City’s Standard Specifications for sidewalk construction. The major difference between a concrete trail and a sidewalk is that a sidewalk is typically not wider than 6 feet. The minimum trail width is 10 feet and 8 feet with a written exception or legal

maintenance agreement with the City. Also, trails have separation between back of curb and sidewalks do not. Thickness typically should typically be four inches (4") minimum, but should be thickened to at least six inches where frequent vehicular traffic is expected (such as at curb access ramps and maintenance vehicle crossings). Addition of color may enhance the visual character of a concrete trail surface, but texturing should be kept to a minimum. Control joints should be saw cut, rather than tooled, in order to maintain a smoother, more even rolling surface.

Asphalt

Asphalt is much less expensive to install than concrete and is used more often than concrete for trail applications. Asphalt is aggregate mixed with oil. It is actually meant to be driven over as the movement of a vehicle over the asphalt literally "kneads" the asphalt keeping it smooth. Therefore, it is recommended and shall be required to use a smaller aggregate for trail applications due to the lack of vehicles "kneading" the asphalt. Parks and Recreation requires "Type C" asphalt which has been typically used since 2010. In lieu of Type C, a super pave IV (SP IV) can also be used however "Type C" is recommended for paved trails. The aggregate is small which helps to keep the trail surface smooth for cyclists and pedestrians. Another concern with asphalt trail surfaces in New Mexico is oxidation (loss of asphalt binder) due to sun exposure, and cracking over time. Both of these problems can be minimized to a small extent through modification of the pavement mix to increase the amount of asphalt binder in relation to the aggregate, as compared to a standard roadway mix. Care should be taken, though, not to increase the binder content to the point that the surface becomes difficult to finish.

Surface thickness also affects the durability of asphalt. Since the design of asphalt surfacing is generally based upon vehicular loads, two inches is usually considered more than adequate to support bicycle and foot traffic. However, since bicycles are not heavy enough to provide the "kneading action" of automobile traffic (which helps hold asphalt roadways together), surface integrity relies solely on the tensile strength of the asphalt binder. Current thinking generally holds that increasing the thickness of the asphalt surface will in turn increase durability and help reduce cracking. Therefore, although the typical trail section in the City's Standard Specifications for Public Works Construction shows 2" of asphalt over 8" of compacted subgrade, the recommended design thickness for trail surfacing when maintenance vehicles will be utilizing the trail consists of 3" of asphalt over 12" of compacted subgrade. In areas with soft (sandy or high clay content) subgrade material, the addition of 4" of engineered base course is recommended. Final determination of subgrade and base course treatment should be made by a qualified civil or geotechnical engineer and it is recommended that 12" of subgrade preparation at 95% compaction rather than 8" of subgrade be used on all new and rehabilitated paved trails. Unless otherwise determined by a civil or geotechnical engineer, aggregate base course should have an "R-Value" ≥ 76 and subgrade should have an "R-Value" ≥ 50 .

Figure 1: Typical Paved Multi-Use Trail Cross Section

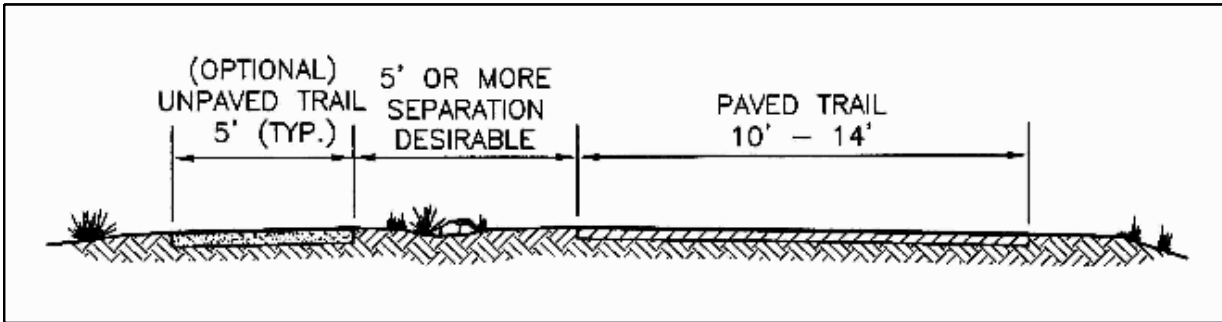
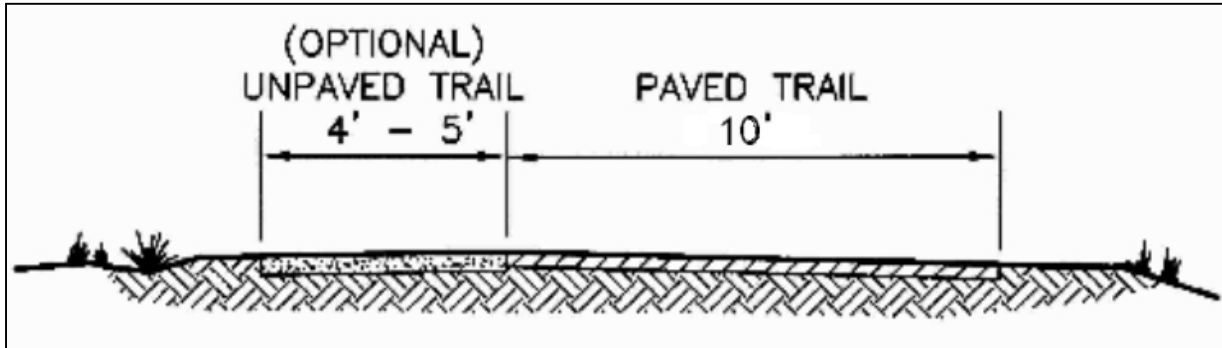

Figure 2: Typical Paved Multi-Use Trail Cross Section (no separation)



Unpaved Trails

Unpaved (non-stabilized) trails within the urban/rural area are sometimes provided as an alternative to parallel paved facilities, primarily for use by equestrians or joggers. However, Major Public Open Space has over a hundreds of miles of unpaved natural surface multi-use trails throughout all quadrants of the City and beyond in Bernalillo and Sandoval County. In many cases, the existing native soil is suitable for surfacing such trails, especially in Major Public Open Space (unless a stabilized crusher fine ADA type trail is desired). These could include 3/8" or smaller angular gravel, crusher fines, decomposed granite, or other suitable soils (e.g. sandy loams) which remain firm underfoot in both wet and dry conditions. A 3"- 4" layer of these imported materials should be adequate in most instances if subgrade soils provide adequate support (greater depth may be required over loose sand or silt). Unpaved trails should be separated from paved trails within the same corridor as far as possible, given right-of-way constraints.

Unpaved trails are typically classified as "singletrack" trails. These are primarily found in Major Public Open Space areas. However, The City Open Space Division also maintains and manages a few paved trails as well. Actually, when looking at the trail system as a network City Major Public Open Space maintains a large majority of trails within the regional Albuquerque area and beyond. Most of these "MPOS" trails differ in design and construction from the paved trail network with exception of the MPOS paved trails but they are just as important and need to be addressed in this design manual as they are considered part of the overall trail network. Some basic MPOS trail designs are listed below for MPOS trails. For more detailed information on MPOS trail standards, trailhead design, signage, etc. please refer to the draft MPOS trail standards. These can found by contacting the Open Space Division directly. Major Public Open Space trails' typical cross sections differ from the paved trail cross sections as seen in figures 1 and 2 above. Each MPOS property is different and trails are designed to accommodate specific environmental terrains and conditions. However, the natural surface trails designed and constructed by the Open Space Division typically follow the International Mountain Bicycling Association publication entitled "Trail Solutions; IMBA's Guide to Building Sweet Singletrack" 2004 edition. Figures 3 through 6 are typical examples used by the Open Space Division for design and construction of MPOS trails. Unless noted as either Major Public Open Space, MPOS, or Open Space in this design manual, all other material is referring to trails that are not MPOS with the exceptions of any paved and maintained by MPOS trail sections such as the northern section of the Paseo del Bosque Trail.

Figure 3: Typical MPOS Singletrack Full Bench Trail

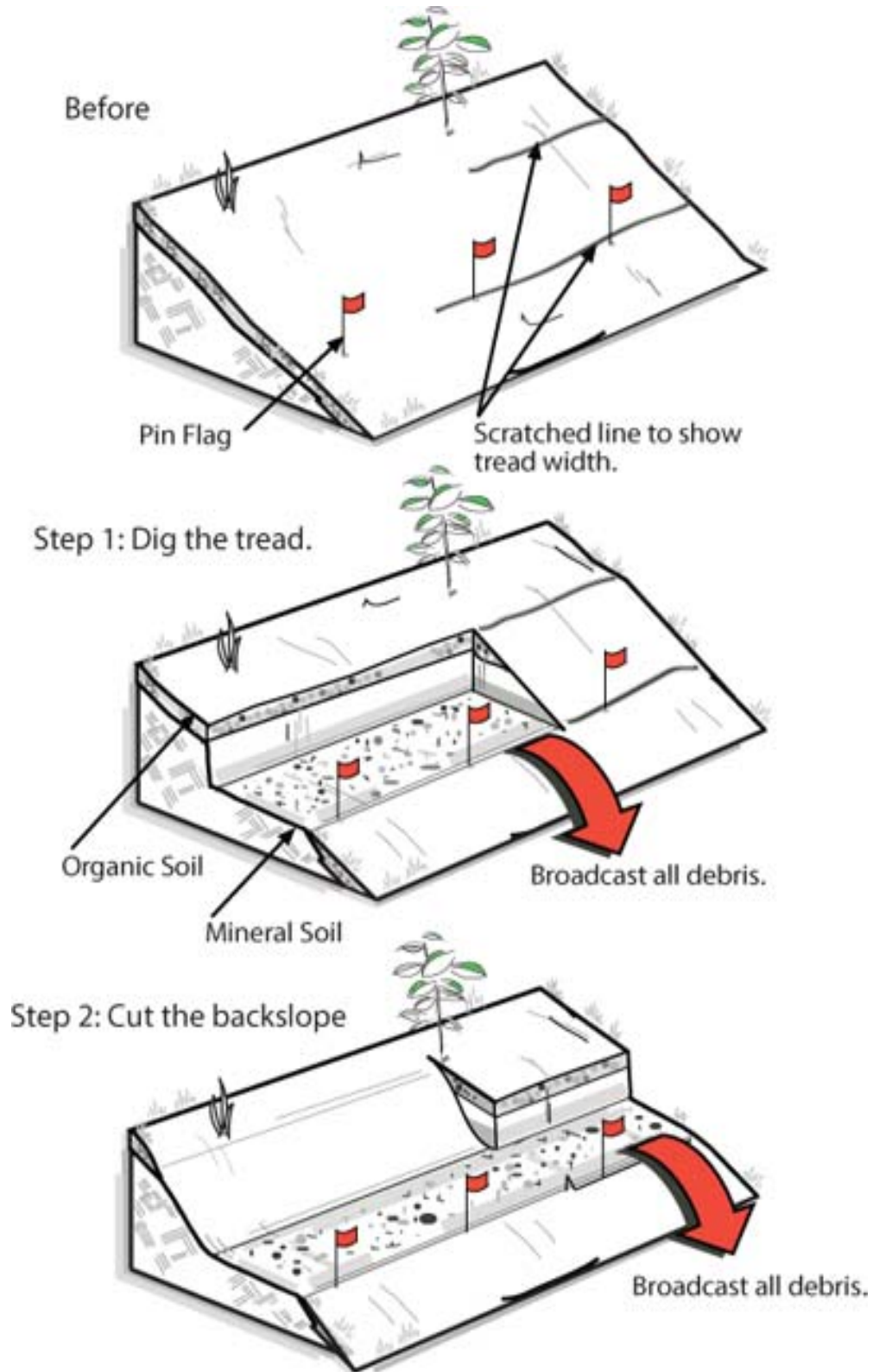

Source: *Trail Solutions: IMBA*

Figure 4: Typical MPOS Singletrack Full Bench Trail (cont.)

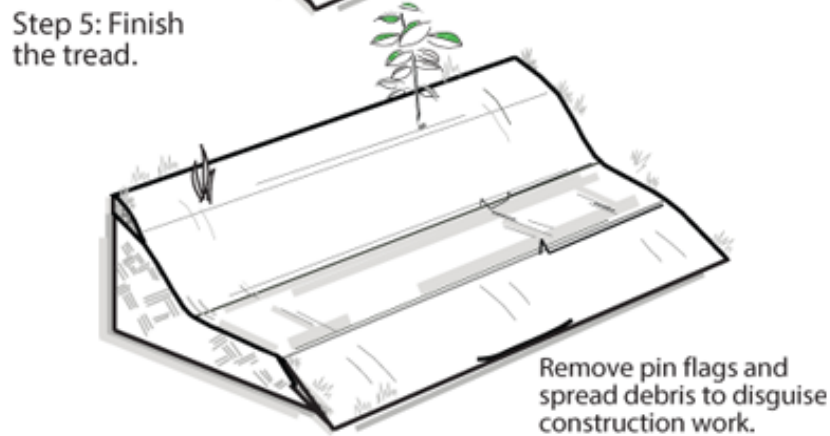
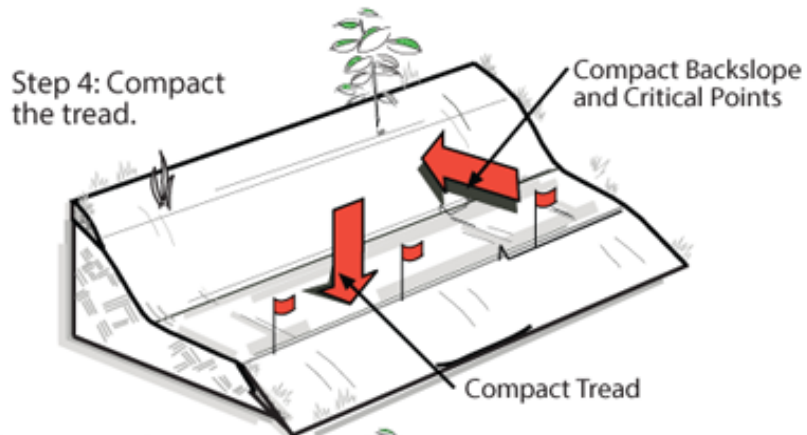
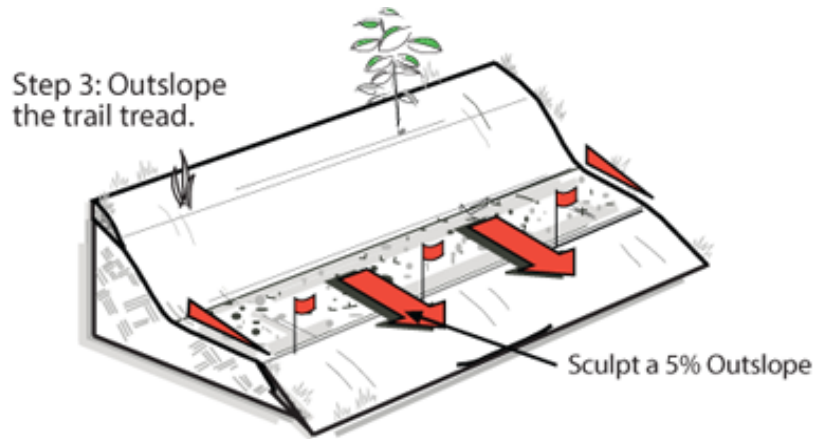

Source: *Trail Solutions: IMBA*

Figure 5: Sustainable Trail Design using the Half Rule
Half Rule

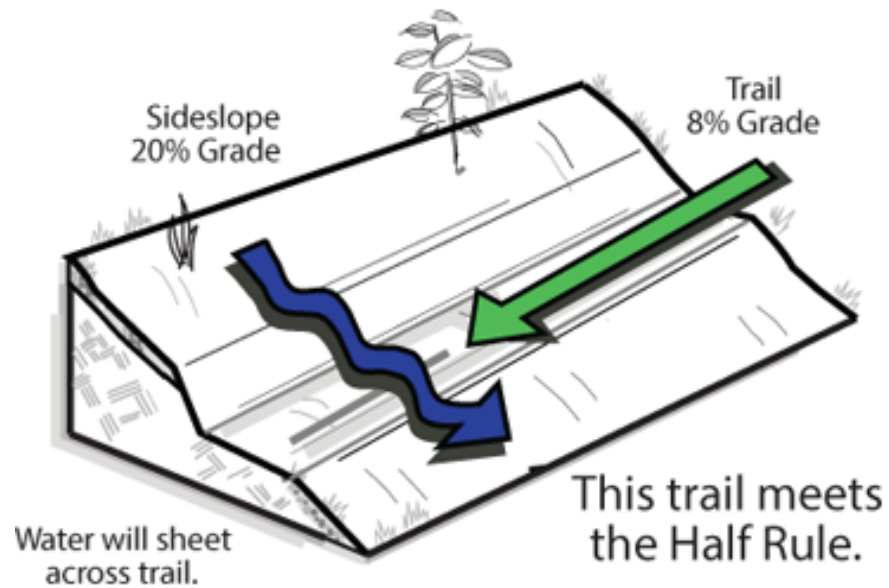
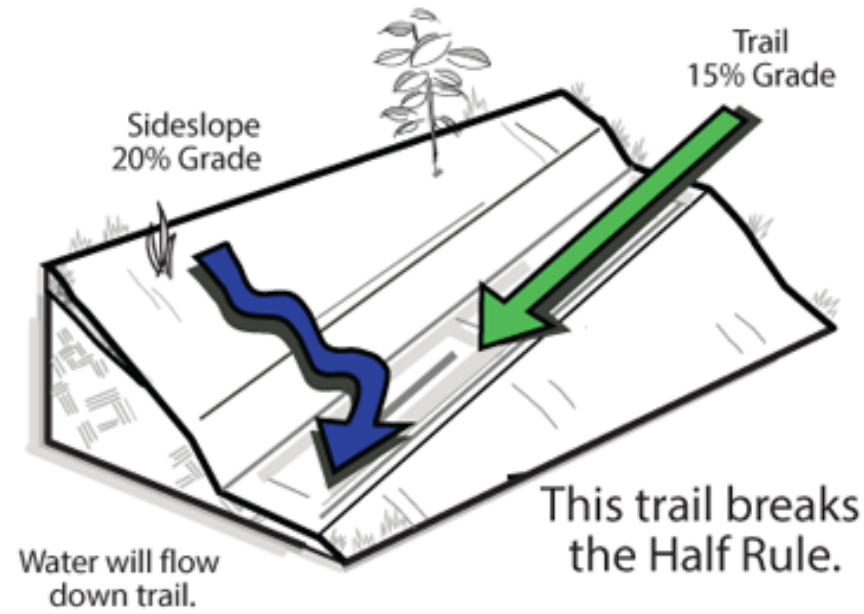

Source: *Trail Solutions: IMBA*

Figure 6: Typical MPOS Design for Natural Retaining Walls

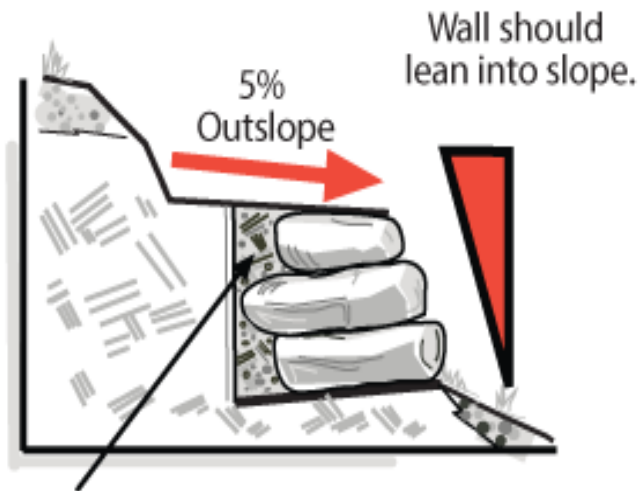
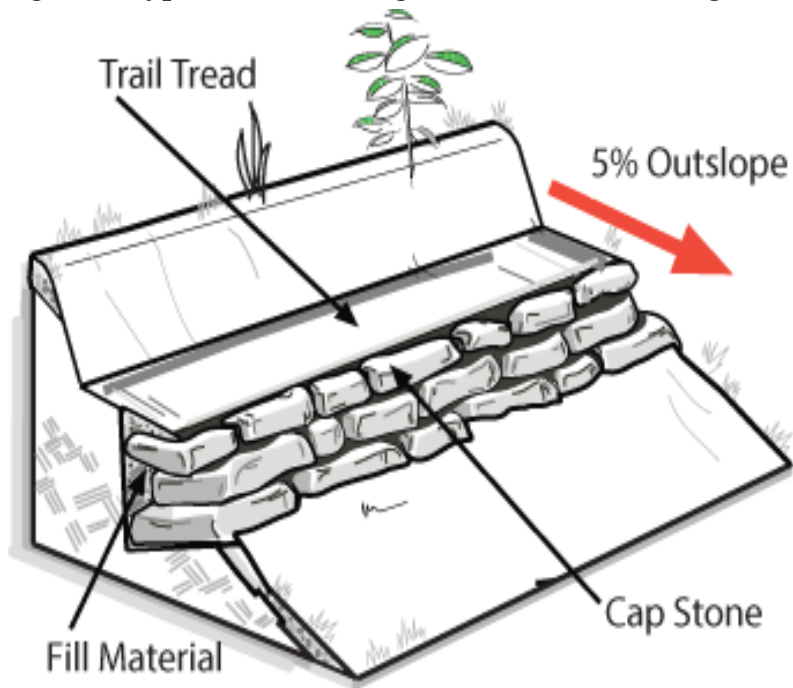

Use only rocks and mineral soil for back fill. Don't use organic material.

Source: Trail Solutions: IMBA

Design Considerations & Guidelines

Asphalt is the most widely used surfacing for paved trails in the Albuquerque area, due primarily to its lower cost, and ease of installation and maintenance. It also offers a smooth surface, if installed correctly, and holds up relatively well over time, since it is not subject to the degree of frost heave or other environmental degradation often encountered in harsher climates.

Concrete is also commonly used for trail surfacing, although less so in Albuquerque than other locations. The primary benefit of concrete is its longevity and smoothness, resulting in reduced maintenance requirements and associated long-term costs. However, its initial installation cost often outweighs the long-term benefit of a concrete surface; especially here in Albuquerque where geographically it is vastly sprawled out and hundreds of miles of trail are needed to adequately connect the City together. Other perceived problems with concrete include the rigidity of the surface (runners usually prefer the flexibility of asphalt) and the somewhat large spacing of the required construction and crack-control joints (esp. for skateboards). These complaints can often be overcome by providing an adjacent soft-surfaced trail for runners, and using saw-cut control joints, rather than tooled joints, in concrete that create a tighter gap.

Environmentally-friendly variations on traditional pavement are also becoming more readily accepted and available. One such variation involves the use of recycled materials (such as shredded tires, plastic, or even crushed glass) in place of a portion of the normal stone aggregate in asphalt or concrete. Another removes the “fines” (smallest components) from the mix aggregate to create a porous pavement, which enables water to pass directly through the pavement and infiltrate into the ground below, thus minimizing runoff. Other alternatives which are gaining acceptance as naturalistic, yet stable trail surfaces involve the use of organic or synthetic binders to form pavements using native soils or other decorative materials; and even the use of brick or concrete pavers. While the use of alternative surfacing may be appropriate in certain circumstances, some of these materials may have limited application for urban trails, due to potential deterioration and/or unevenness of the surface. In any case, sound engineering judgment should be used in determining suitability of materials for trail use on any given project.

Trail Dimensions (7.C.3.c)

Trails should be of sufficient width to accommodate expected numbers of users without excessive interference. Side slopes and clearances from adjacent obstacles should be designed to minimize danger to cyclists who may inadvertently stray from the paved surfacing. Shoulders should provide a stable recovery surface in those instances. Railings (addressed later) may also be used to keep trail users from leaving the paved path, and may be placed within the 2'-3' clear (recovery) zone illustrated below. Refer to the AASHTO Guide for additional information not addressed here.

Design Standards

Typical paved trail dimensions and clearances are shown in Figure 7, below.

Figure 7: Paved Trail Dimensions and Clearances

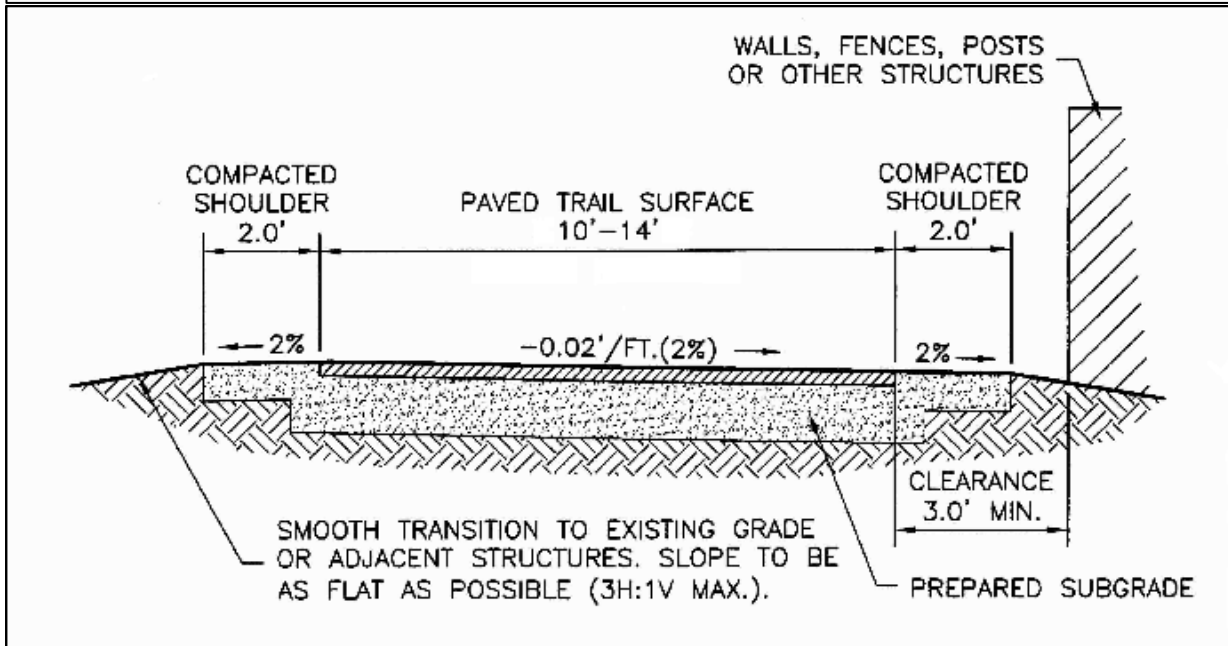
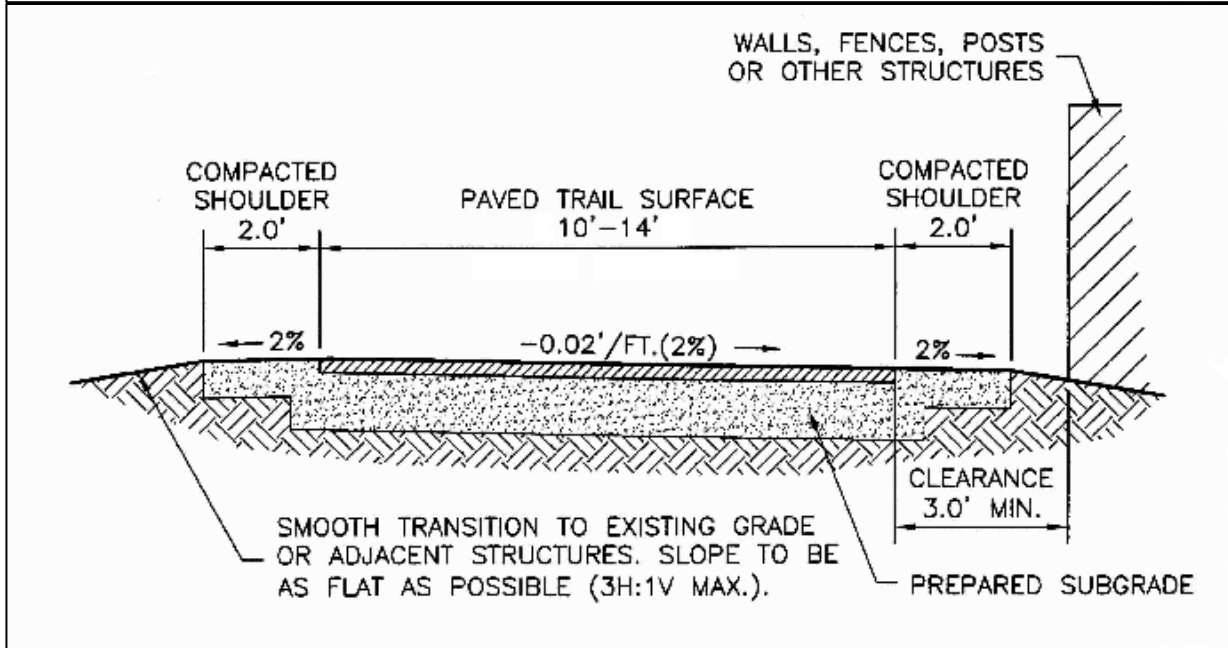
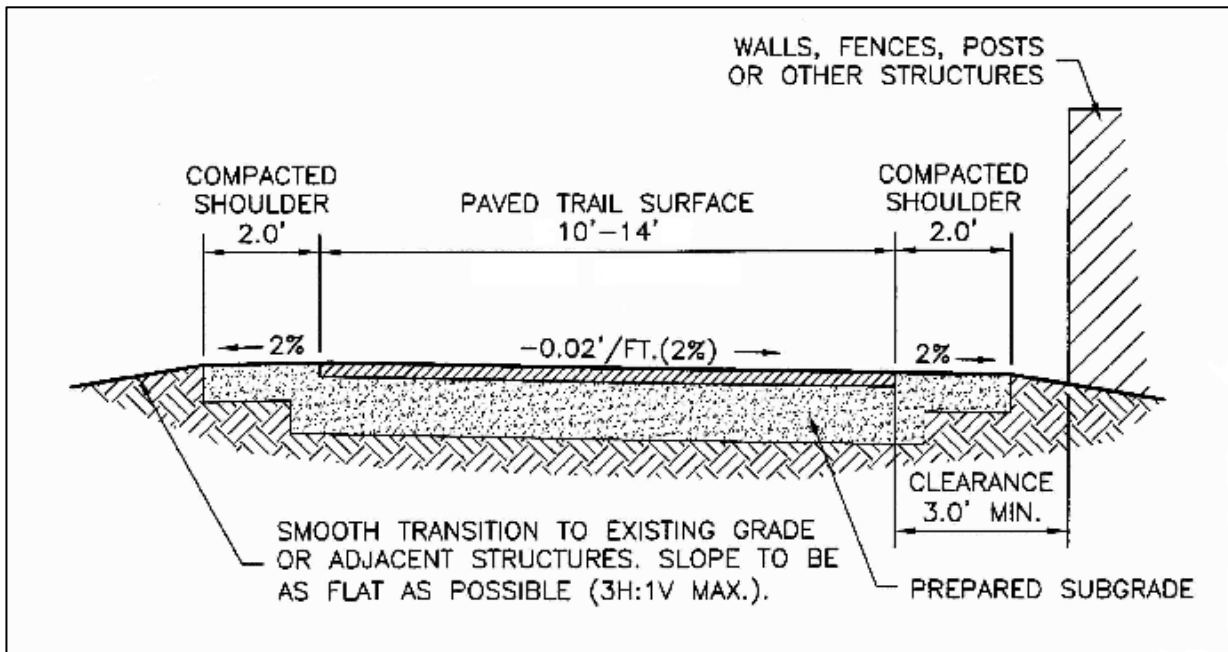

Shared-use paths should be constructed according to this design manual and to the AASHTO Guide for the Development of Bicycle Facilities when and where feasible. Shared-use paths will be designed according to American with Disabilities Act (ADA) standards when a Federal ruling is adopted by the Access Board. In the meantime, trails (paths) will be constructed using the best ADA practices as adopted through the “Public Rights of Way Accessibility Guidelines” (PROWAG) when and where possible. Constructing trails may have limitations that make meeting ADA standards difficult and sometimes prohibitive. Prohibitive impacts include harm to significant cultural or natural resources, a significant change in the intended purpose of the trail, requirements of construction methods that are against federal, state or local regulations or presence of terrain characteristics that prevent compliance. Parks and Recreation is currently (started in 2013) auditing all paved trails for ADA compliance. Once the audit is completed, the report will show how many miles of trail and which trails can be utilized by people with disabilities.

Design Considerations & Guidelines

Shared-use paths serve cyclists and pedestrians and provide additional width over a standard sidewalk. Facilities may be constructed adjacent to roads (sidepaths), through parks, or along linear corridors such as active or abandoned railroad lines or waterways. Regardless of the type, paths constructed next to the road should have some type of vertical (e.g., curb or barrier) or horizontal (e.g., landscaped strip) buffer separating the path area from adjacent vehicle travel lanes. However, sometimes right of way restrictions hinder the possibility for a vertical or horizontal barrier. It will be determined the engineers, designers, and planners if the benefits of having a trail outweigh the risks when the ROW is constrained.

Elements that enhance shared-use path design include:

- Providing frequent access points from the local road network. If access points are spaced too far apart, users will have to travel out of direction to enter or exit the path, which will discourage use.
- Placing directional and way finding signage to direct users to and from the path.
- Building to a standard high enough to allow heavy maintenance equipment to use the path without causing it to deteriorate.
- Limiting the number of at-grade crossings with streets or driveways.
- Terminating the path where it is easily accessible to and from the street system, preferably at a controlled intersection or at the beginning of a dead-end street. If poorly designed, the point where the path joins the street system can put pedestrians and cyclists in a position where motor vehicle drivers do not expect them.
- Identifying and addressing potential ~~safety and~~ security issues up front.
- Whenever possible, and especially where heavy use can be expected, separate bicycle and pedestrian ways should be provided to reduce conflicts.
- Providing accessible parking space(s) at trailheads and access points.

- Providing, where possible, a soft surface shoulder adjacent to paved surfaces for use by joggers and equestrians.

Trails should be of sufficient width to accommodate expected numbers of users without excessive interference. Side slopes and clearances from adjacent obstacles should be designed to minimize danger to cyclists who may inadvertently stray from the paved surfacing. Shoulders known as the “recovery zone” should provide a 2-3’ stable recovery surface in those instances. Compacted base course, subgrade, or crusher fines are recommended and gravel should not be used unless the aggregate is finer than 3/8”. Railings (addressed later) may also be used to keep trail users from leaving the paved path, and may be placed within the 2-3’ clear zone illustrated below. Refer to the AASHTO Guide for additional information not addressed here.

Trail Alignment (7.C.3.d)

Although multi-use trails are, by definition, intended for many modes of use, the design of those trails is effectively determined by only a few user groups – those with the most stringent requirements. In the case of paved trails, this presents something of a conundrum, in that the design must accommodate two sometimes-conflicting extremes. Bicycles, on the one hand, are a very efficient means of transportation, capable of fairly high speeds and long distances. Wheelchairs, on the other, are relatively inefficient and slow. While both have wheels, and therefore share some basic requirements in terms of surfacing, most other design requirements for the two are quite different. In order to accommodate wheelchairs which typically have shorter travel distances and may need frequent rest stops on as many multi-use paths as possible, shared-use paths will need to meet the requirements of the Americans with Disabilities Act (ADA) once a proposed ruling by the Access Board is adopted by the Department of Justice as an “enforceable standard”, which currently does not exist for shared-use paths. In contrast, AASHTO guidelines for bicycle design focus on higher travel speeds, and efficiency of movement. Nonetheless, the two are not mutually exclusive. Trail designers must find the common ground between the two seemingly contradictory sets of criteria, and work within those parameters. In the simplest of terms, while the overall design of a trail facility should obviously take both modes into consideration, bicycles tend to dictate horizontal alignment criteria, while wheelchair requirements drive the vertical alignment.

The information which follows is a summary of trail design criteria which should satisfy both ADA and AASHTO for use in the design of Albuquerque’s urban multi-use trails.

Design Standards

Table 2: Maximum Recommended Running Grade Lengths

Max. Running Grade	For Distances Up To:
5% or less	Unlimited
8.33%	200 ft. with resting intervals
10%	30 ft. with resting intervals
12.5%	10 ft. with resting intervals

* Defined under ADA accessibility guidelines for outdoor areas

Table 3: Minimum Recommended Curve Radii for Paved Trails

Grade	Design Speed	Min. Centerline Radius*
less than 3%	20 mph (30 km/hr)	95 ft. (29 m)
3% - 5%	25 mph (40 km/hr)	160 ft. (49 m)
greater than 5%	30 mph (50 km/hr)	265 ft. (81 m)

* Assumes 2% superelevation (cross slope in direction of curve)

Table 4: Recommended Vertical Curve Radii for Paved Trails

Grade Change (Algebraic Difference)	Minimum Length for Crest Curve	Minimum Length for Sag Curve
less than 2%	None Required	None Required
2% - 4%	10 ft. (3 m)	60 ft. (18 m)
>4% - 6%	60 ft. (18 m)	160 ft. (49 m)
>6% - 8%	100 ft. (30 m)	300 ft. (91 m)
greater than 8%	160 ft. (49 m)	500 ft. (152 m)

Design Considerations & Guidelines

Grade

Trails in the urban area should be designed to provide running grades of 5% (20H:1V) or less wherever possible. If necessary, due to existing terrain or right-of-way constraints, grades up to 12.5% (8H:1V) are permissible, provided that a rest area be provided every 10 feet (77 cm) of vertical rise. See table 1 above for running grades and recommended resting intervals. Such rest areas may be integral with the trail (i.e. a landing with a maximum grade of 2.03% at least 5 feet in all directions of the landing pad), or, with approval of the City's project manager, may be offset alongside the trail, in order to provide a more even surface for bicycles and other faster-moving uses. Table 1 lists recommended maximum distances for

various trail grades under the current most stringent ADA guidelines for outdoor recreation areas. It should be noted that the natural environment terrain and grade may prohibit ADA compliance. This is allowed as long as the entire system or trail network has a certain amount of ADA accessible trails located throughout the City. In addition, the standards may be waived where compliance would cause “substantial harm to cultural, historic, religious or significant natural features or characteristics.”

Horizontal Curves

Many factors, including design speed, tire friction, lean angles, sight distances, and braking capabilities, are involved in determining minimum acceptable dimensions for horizontal alignments of bicycle facilities. These are covered in detail in the AASHTO Guide [pp. 37-46]. By default, facilities which are designed to facilitate the turning movements of two-way bicycle traffic would easily accommodate the spatial requirements of wheelchairs and other slower modes of travel. However, the same is not true for vertical alignment. It is, in fact, difficult to separate horizontal and vertical alignment criteria, so the designer should carefully weigh the impact that any changes to one might have on the other. As can be seen in the tables in the Design Standards below, the grade selected for a vertical alignment affects design speed, which in turn affects the minimum turning radius.

Curves sharper than those in the table below may be necessary in circumstances of limited right-of-way or other physical constraints. If so, such curves should be identified by solid centerline striping and warning signs per the MUTCD.

Vertical Curves

Vertical curves are used to make a smooth transition at changes in trail grade. This issue comes most sharply into focus in the design of ramps which meet the letter of ADA requirements, but also must serve bicycles. The typical alternating 30-foot, 12:1 (8.33%) ramp and 5- to 10-foot level landing configuration (often seen on bridge approaches and other areas of significant grade change) makes for abrupt transitions and runs contradictory to the 30 mph design speed recommended in the AASHTO Guide for such grades. Adding at least a short vertical curve at each change in grade will provide a much smoother travel surface, and ~~increase user safety~~ lessen the potential for accidents by minimizing the chance of bicycles (and even some other modes of wheeled use) becoming airborne.

The most recent AASHTO Guide provides tables listing minimum lengths of Crest Vertical Curves (e.g. over the top of a hill) [pp. 43, 44], but no longer provides that information for sag curves (e.g. at the bottom of a valley), stating only that the minimum length of a vertical curve should be one meter (3 ft.). The previous (1991) AASHTO publication did not differentiate between the two types, offering a single graph [p. 29] that presented minimum lengths for any vertical curve based upon grade differential and design speed. The current differentiation is due to the fact that crest and sag curves are governed by different criteria. While crest curves can occur either at the top of a hill or in the middle of a slope, in both cases approach speeds are generally slower than exit speeds. Nonetheless, stopping sight distance

(the distance that the trail surface is visible ahead) is usually the primary concern, since the slope is breaking away from the user. Sag curves represent the opposite conditions, and usually see the highest speeds on the approach to the grade change. Visibility is rarely an issue; instead, user comfort and ease of negotiation (due to resultant “G” forces) are the main criteria. So while the AASHTO guide has relaxed its recommendations for vertical sag curves, the resultant abrupt change in some instances might make for uncomfortable riding conditions for cyclists. In lieu of the 3’ minimum requirement, Table 3 below suggests vertical curves which will make for a more pleasant trail experience.

In general, vertical curve grade transitions should be designed to provide as gentle a transition as possible, given the physical constraints of a site. The table below provides suggested lengths of vertical curves for various conditions, based on 2% increments in grade change. These numbers are generalized and should provide acceptable results in most cases; however, if more detailed information is required, please refer to the current AASHTO Guide.

As with horizontal curves described above, there will undoubtedly be instances when such lengths cannot be achieved in designing vertical curves. In the case of the accessible ramp design described above, provision of even a short vertical curve at each grade transition will permit easier negotiation by bicycles.

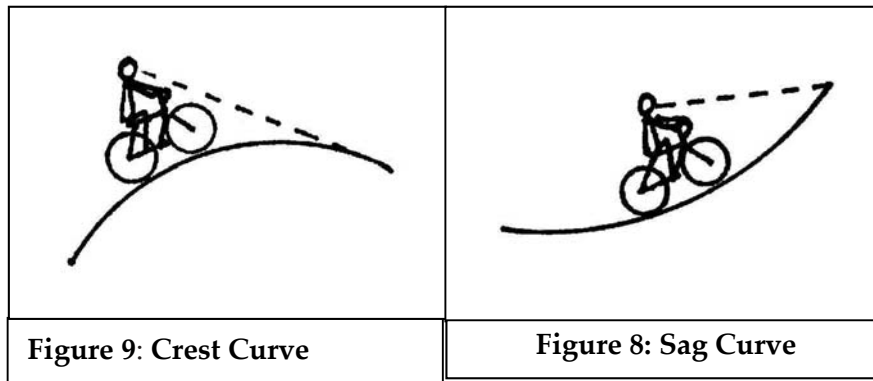

4. Drainage

Since many trails follow drainage features (e.g. arroyos or ditches), they often must address not only drainage issues related to the trails themselves, but also accommodate runoff originating elsewhere. In fact, “neighborhood access” to a trail is often provided via wide rundowns which carry storm water from adjacent streets into shared arroyo/trail corridors. This is not a desirable configuration. Both the water itself, and the silt and debris which invariably accompany it, make for potentially hazardous trail conditions. Instead, parallel facilities should be provided which keep the trail access separate from the drainage way, or the trail access tread can be elevated six to eight inches above a low-flow channel within the rundown (Figure 10). Likewise, when trails cross drainage rundowns along the edge of a channel, the drainage flow should be routed under the trail, rather than across it.

Figure 10: Neighborhood Trail Access via Shared Drainage Rundown

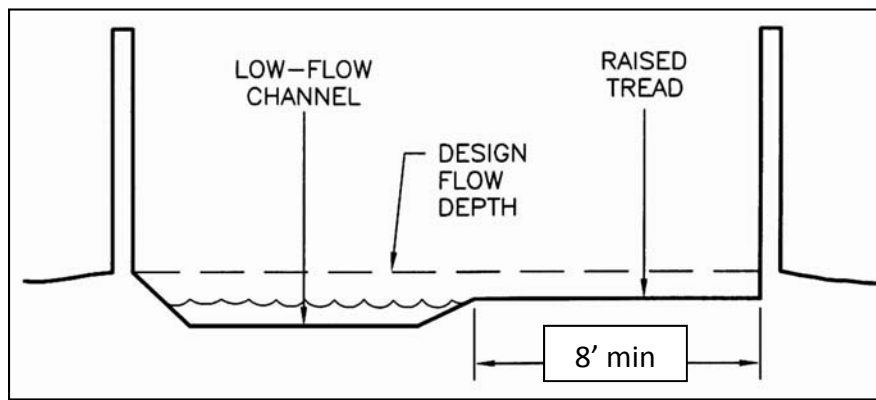

Design Considerations & Guidelines

In general, drainage design for trails does not differ greatly from drainage design for roadways. Nonetheless, a few key principles should be highlighted here:

- Trail surfaces should have a 1% to 2% cross slope, and uniform surface planarity (no depressions or “bird baths”) in order to prevent water ponding on the trail;
- Interception ditches should be provided on the uphill side of trails which traverse slopes or hillsides, to prevent runoff from washing sediment onto the trail;
- Drainage grates or other structures should be sized and/or located so as not to interfere with trail traffic (narrow bicycle tires in particular).
- Culverts should be sized adequately to pass expected flows and allow for easy maintenance, including removal of debris. Minimum culvert size should be 12” diameter; 18” diameter is preferred for maintenance purposes.



Albuquerque has significant opportunities to develop trails along drainage ditches.

Equestrian Facilities (7.C.4.a)

Design Standards

Width

- 5-6 feet in low (rural) development
- 8-12 feet in moderate to high development

Lateral Clearance

- A 3 foot or greater shoulder on both sides.

Overhead Clearance

- Clearance to overhead obstructions should be 10 foot minimum, with 12 feet recommended.

Design Considerations & Guidelines

With a multi-use trail system, planners and designers should always work to incorporate facilities that will accommodate all trail users whenever possible and feasible. Equestrians often are not thought about when designing in more urban trail areas. With an ever growing and interconnected trail system that extends from rural to urban, equestrian design should always be incorporated. Specifically, a bridge or tunnel should be expected to be used by equestrians and additional criteria should be taken into consideration:

- Overhead clearance is particularly important to accommodate both horse and rider. Ten-foot clearance is a minimum (twelve feet is preferred) without requiring the rider to dismount or duck.
- Horses may be frightened by the sound and motion of traffic beneath them, which could, in turn, result in injury to the rider. Therefore, equestrians tend to prefer underpasses to bridges. (However, adequate sight distances are critical. Poorly designed underpasses can also be dangerous, if, for example, a fast-moving bicycle suddenly appears within the confines of a narrow tunnel.) If a bridge is the only alternative for an equestrian crossing, solid side walls or other screening should be provided for at least three feet up from the bridge deck to minimize visibility of traffic below.
- Trail etiquette signs are triangular and look like yield signs and should be placed throughout the trail system/network. See [figure X](#) which is the current sign being used by the Parks and Recreation

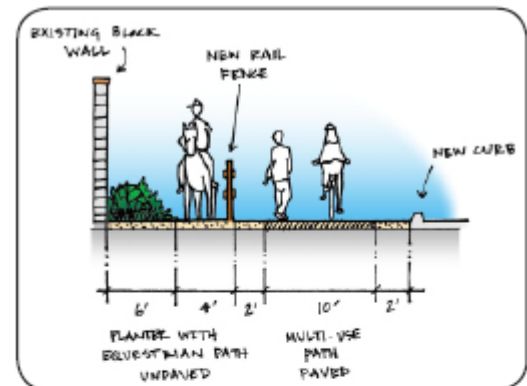

Recommended design for a multi-use path that accommodates equestrians.



Example multi-use equestrian trail.

Department in the greater Albuquerque area. These signs help to educate trail users understand who has the right of way when approaching and passing each other. The sign is typically made to be 24x24 inches in size.

Walkers, hikers and cyclists often share trail corridors with equestrians. Pedestrians and riders are often compatible on the same tread as they both accept unpaved surfaces and move at relatively slow speeds. However, fast moving and quiet cyclists approaching a horse from behind are a valid concern for riders. In areas where conflicts seem likely, efforts are made to physically separate the different user groups.

For equestrian routes, trail tread or surface should be relatively stable. The trail surface should be solid, obstacle-free and should stay in place. Appropriate trail surfaces include: compacted native soil, crusher fines and decomposed granite. Hard surfaces, such as asphalt and concrete are not amenable to equestrians.

Trails that are comfortable for equestrians are ones that accommodate most trail users. While horses can easily negotiate grades up to 20 percent for short distances (up to 200 feet), steeper running grades result in faster water run-off and erosion problems. Following contours helps reduce erosion problems, minimize maintenance needs and increase comfort levels. A 2 percent cross slope or crowned tread and periodic grade reversals along running slopes will minimize standing surface water and will resolve most drainage issues on a multi-use path. An exception is to cut sections where uphill water must be collected in a ditch and directed to a catch basin, where the water can be directed under the trail in a drainage pipe of suitable dimensions. Additionally, on running grades steeper than 5 percent, add 6-12 inches of extra tread width as a safety margin to enhance user comfort where possible.

- USDA/FHWA Equestrian Design Guidebook for Trails, Trailheads, and Campgrounds.

Shared Use of Drainage Facilities (7.C.4.b)

In recent years, the shared use of drainage channels for underpasses beneath major roadways has become more commonplace in the Albuquerque area. Trails are most often accommodated through such crossing by creating a notch in the side of the channel, with ramps leading in and out of the crossing. Less frequently, suspended platforms have been mounted on the side of the channel where adequate flow capacity exists. The notched configuration, while significantly more expensive, is generally preferred by drainage authorities because it does not impede the flow of water in the channel, and, in fact, increases the channel cross section (and carrying capacity) at the bridge crossing. Figures 11 - 13 show possible configurations of such a crossing, based upon the depth and capacity of the channel at the crossing.

Figure 11: Trail Underpass Notched Into Side of Channel

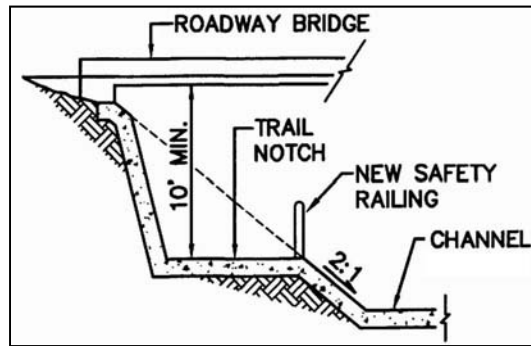

Figure 12: Depressed Underpass for Low Bridge Clearance Condition

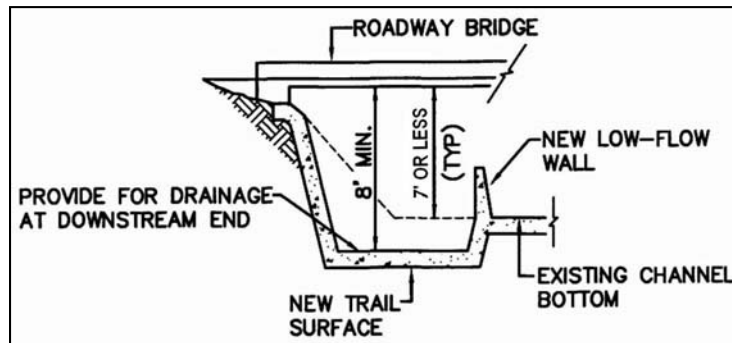
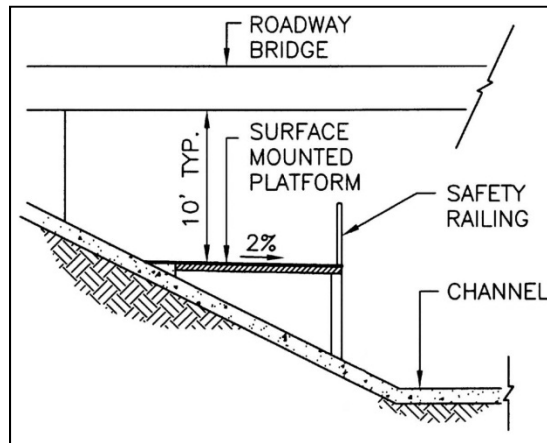

Figure 13: Trail Underpass Attached to Channel Surface



One of the primary concerns about placing trail crossings within major drainage channels lies in the fact that users are essentially directed into a potentially dangerous situation, where storm runoff may inundate the trail. Although the probability of such an occurrence would be quite low at any given time, it is nonetheless a valid concern. The safety-potential hazard of such a crossing can be greatly ~~increased~~ decreased through the following actions:

- Provide safety-hand railings at the edge of the trail surface, in accordance with the Access Control section below.

- Post signs at either end of the crossing warning users not to enter the underpass if water is present or flowing across the trail surface.
- Provide alternate, at-grade crossing opportunities for times when the trail crossing may be flooded.
- Design notch configurations to keep the trail surface above the nominal “10-year design flow” depth, and such that inundation of the trail would be minimal for a “100-year” flood event.

If trail users heed the second guideline above, the last one would not be much of an issue. However, the fact remains that common sense does not always prevail, or that a trail user might unintentionally end up in such a situation (e.g. brake failure or other unforeseen mishap). While no national standard exists for acceptable flow depth across a trail, depths of two to three feet greater than one-foot should be viewed as the maximum allowable condition. Any deeper, and stormwater flows begin to obscure the railing at the trail edge, limiting or eliminating the safety benefit it should provide.

Shared Use of Irrigation Ditches (7.C.4.c)

~~Any trail proposal for an MRGCD owned or managed facility has to be reviewed and approved by us for adequate right of way, current management and maintenance of that facility, landownership and ability for another local entity to manage and maintain the trail through a license agreement. The size of the facility and available right of way are strong determinants in the feasibility of a multi-use trail that can be separated from the MRGCD's required maintenance access. Other than at road crossings, rails and fences are generally not installed along ditch banks as they prevent or impede our access and maintenance.~~

~~Equestrians use unimproved maintenance roads and trails on our facilities and generally keep distance from bicycles and other fast moving users. Our ditches and drains are used by and very important to equestrians in the valley and we try to provide or maintain access wherever feasible/desirable.~~

~~Wherever possible, multi-use trails should meet ADA standards for design and access. It's helpful to make them higher in elevation than the maintenance road for drainage and so less material migrates onto the trail. The opinion about bollards is that they can cause some hazards on a trail but we are increasingly using them rather than the horse log step overs to provide better access for those who have more mobility issues, bicycles, strollers, etc. while excluding vehicles and four and three wheelers (ATVs).~~

~~The trail corridors proposed for the Corrales Main Canal and Alameda Drain will need more study for feasibility. Some funding has been allocated for the Alameda Drain from Matthew Ave. north to Alameda Blvd. and reconnaissance and coordination efforts have commenced.~~

~~It would be good for the MRGCD, City and County to develop maintenance and management standards and signage/information more specific to trails on MRGCD facilities as the concerns, management, opportunities and purposes are unique.~~

Shared Use of Utility Corridors

PNM transmission rights-of-way or easements are identified as the location for several proposed bike routes or trails. As the easement holder, PNM has the legal right to use and maintain the easement including ensuring vehicular access to the lines, maintaining adequate clearances, and other safety measures. If the bike lanes and/or trails become guest uses at these locations, an encroachment agreement will be necessary. The City also needs to directly contact the underlying property owner. In addition, it will be the City of Albuquerque's responsibility to ensure that PNM's uses of the easement are not affected or interfered with in any way by the inclusion of the bike lane or trail.

Four proposed bike lane and/or trail locations are identified within PNM's 115kV transmission rights-of-way and easements. The four locations are:

- Along the PNM CE 115kV transmission line from Irving Blvd. NW heading north toward McMahon Blvd. NW
- Along the PNM BW 115kV transmission line north of Interstate 40 east of Atrisco Vista Blvd NW
- Along the PNM SE 115kV transmission line/ID 46kV transmission line corridor in Tijeras Arroyo
- Along the PNM RE/ER 115kV transmission line corridor on San Antonio Drive NE just west of Tramway Blvd NE

Based on PNM's experience constructing and maintaining facilities at these locations, the terrain is difficult and is not conducive for bike trails. Coordination with PNM will be necessary as trails are developed at any of these four locations.

PNM does not support the development of trails within PNM existing 345kV transmission line rights-of-way or easements. The higher voltage lines can potentially result in electrical nuisance shocks. Nuisance shocks may occur when a person touches an ungrounded metal object, in this case, such as bicycle handlebars. A nuisance shock does not harm the recipient but can be startling. PNM will not grant an encroachment easement in 345kV transmission corridors.

Trail Accessibility (7.C.4.d)

Design Standards

- 3 feet minimum clear width, where less than 5 feet, passing space should be provided at least every 100 feet.
- Cross slope should not exceed 2 percent where and when possible.
- Curb ramps shall be provided at roadway crossings and curbs. Tactile warning strips and auditory crossing signals are recommended along with any other mandated ADA street crossing criteria.

Running slopes typically should not exceed 5%. However, certain conditions may require the use of steeper slopes for grade separated crossings (refer to table 1 for recommended maximum running slopes).

- The trail surface shall be firm and stable. The Forest Service Accessibility Guidelines defines a firm surface as a trail surface that is not noticeably distorted or compressed by the passage of a device that simulates a person who uses a wheelchair. Where rights-of-way are available, paths can be made more accessible by creating side paths that meander away from a roadway that exceeds a 5% slope.

Design Considerations & Guidelines

- General guidelines have been created in response to the ADA for accessible trails.
- FHWA. (2001). Designing Sidewalks and Trails for Access, Chapter 14: Shared Use Path Design, Section 14.5.1: Grade.

www.fhwa.dot.gov/environment/sidewalk2/sidewalks2_12.htm#tra2

- Regulatory Negotiation Committee on Accessibility Guidelines for Outdoor Developed Areas Final Report, (1999). www.access-board.gov/outdoor/outdoor-rec-rpt.htm

Access Control (7.C.4.e) – Ensure consistency with DMD Bollard Study

Access control devices are intended to ~~assure~~ minimize the potential for trail user safety conflicts by restricting vehicular access to trails or serving as barriers from dangerous conditions. Access control measures can include, but are not limited to, railings, fences, gates, and bollards or guard posts. Landscaping and/or natural features can also be used

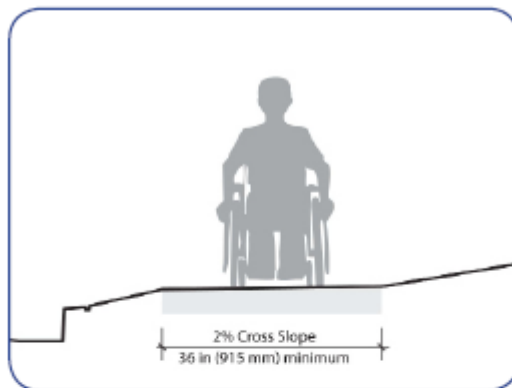

ADA clearance requirement.



Shared-use paths surfacing materials affects which types of users can benefit from the facility.

effectively for access control in some settings. Each type of access control has its place, as indicated in the Design Guidance below.

Design Standards

Bollards/Guide Posts

Bollards should only be used or installed in areas where it is likely a vehicle will mistake the trail for a possible vehicular road or where there have been documented claims that vehicles have been driving on the trail. Bollards have become more of a hazard to trail users than users being run over or into by illegal vehicle trespass on multi-use trails. Therefore, bollards should be installed on an as needed basis rather than adding them to every project and crossing of streets. When determined they are needed, access control bollards may be made of any number of materials, including but not limited to: wood, concrete, plastic (PVC), or steel, as appropriate to a particular setting. Sizing should be appropriate for both maximum visibility and as a visual deterrent to motor vehicles. Surfaces of the bollard should be relatively smooth, with no protruding objects to snag on clothing or appendages of passersby. Selection of bollard materials is less important than their placement. If deemed necessary for a particular trail access point, bollards should be placed only in the center of the trail and (if additional protection is necessary), at either edge. For a typical ten-foot trail, this would result in two five-foot-wide accessible openings on either side of the trail centerline. In specific situations where ATV access must be addressed such as within AMAFCA facilities, bollard spacing may be reduced to provide a minimum 36"-wide clear opening on either side of the trail centerline. This will permit wheelchair access, but exclude all but the smallest ATVs (and motorcycles). Bollards should be brightly painted and reflectorized for greater visibility, especially in low light conditions. A specific diamond shaped stripe shall be placed around center bollards per AASHTO (see figure 14). If maintenance and emergency vehicles are expected to gain access via the trail itself, access control bollards should be designed for easy removal or collapse. Otherwise, gates should be provided in adjacent fences or railings to permit such access. Consultation with local authorities is advised in such situations.



Bollards deter motorists from driving on the trail, but they can be dangerous for cyclists, particularly on a busy trail.



Bollards and pavement change prevent motor vehicles from using the trail.

[Although AMAFCA currently requires 36-inch maximum spacing on bollards, the proposed PROWAG standards will require 48-inch spacing. A minimum of 48-inch spacing is required to pass certain types of cycles for ADA use such as those that have parallel seating and are over 36 inches wide.](#)

Figure 14: Typical Striping around Bollard

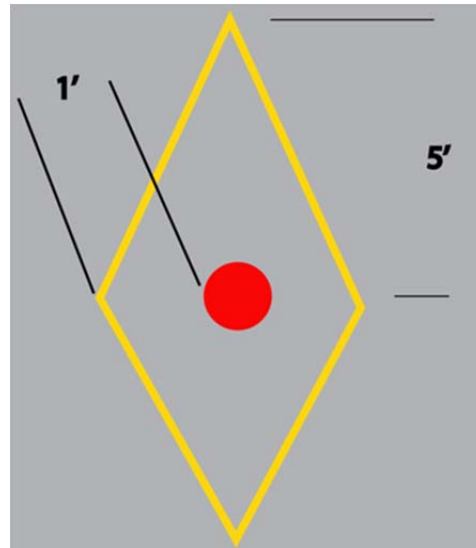

Following is a list of best practices that should be consistent when installing bollards at any trail facility by the City of Albuquerque:

- Only apply bollards if the need is demonstrated, or if the trail entrance cannot be designed or modified to discourage use by unauthorized motor vehicles. Bollard use should be reserved for problematic locations.
 - Bollards should not be installed on trail facilities that parallel a roadway unless it is identified as a problematic location.
 - Bollards should be considered along obscured facilities that are not readily visible and at other problematic locations.
- All bollards should be made of a retro-reflectorized material or have retro-reflectorized tape affixed to them for easy visibility from both approaches to the bollard.
 - Where possible, retractable bollards should be implemented. Appropriate usage ensures that the bollards will remain in place and cannot be removed from the site and when retracted, the bollard will not be a hazard as there is no “collar” that sticks up when the bollard is removed due to this type of bollard retracting into the ground rather than coming off.
- Bollards should be 40 inches in height (minimum) and 4 inches (minimum) in diameter to ensure visibility but short enough to not interfere with handlebars on cycles.

- In most instances, a single bollard should be placed at the centerline of the trail, where adequate sight distance is available.
 - An even number of bollards shall never be used as they typically will be placed in the center of the travel way for each travel direction and they tend to direct users into each other causing confusion.
 - If it is necessary to restrict access adjacent to the multi-use trail to restrict motorized traffic, bollards should be placed a minimum of 2-feet off of the edge of the trail.
- A minimum clear width of 5 feet should be provided between the edge of trail and the edge of the bollard.
- A striped envelope (4 inch wide, retro-reflective yellow “diamond”) should be striped around the bollard to provide guidance to divert users around the bollard. A striped yellow centerline should also be provided along the trail for 25-feet on either side of the bollard. See [figure 14](#)
- Bollards should be set back 30-feet from the roadway to separate the conflict point for users between the roadway and bollards, or as far back as is practical based on site conditions.

These recommendations are consistent with what the Parks and Recreation Trails Planner drafted in 2012 and a draft paper developed by the Greater Albuquerque Recreational Trails Committee (GARTC) (**Appendix C**) as well as ideas coming from a coordination meeting held July 22, 2013. Standards to ensure consistent application should be implemented by all departments of the City of Albuquerque. Every trail and entrance are unique and special consideration will need to be given to each site to determine how best to place bollards, if the need for bollards is demonstrated.

Design Considerations & Guidelines

In recent years, the use of bollards as trailhead access control has become the subject of some debate. Posts or bollards have commonly been used to restrict vehicular access at roadway intersections. In addition, they serve a secondary purpose of warning trail users of the upcoming intersection. On the other hand, bollards also present obstacles for trail users to negotiate, and therefore become potential hazards, particularly in times of low visibility. While there is not yet consensus on the issue, it is increasingly held that in older, established areas of the city, where people are familiar with the existence of non-vehicular trails, bollards may no longer be necessary.

Trailhead access control can also take other forms beyond the use of posts or bollards. An attractive alternative might involve dividing the trail into two one-way paths, half the width of the total trail, with a landscaped median or other central barrier ([Figure 15](#)). The resultant one-way paths are generally narrow enough to discourage vehicular access, while better defining trail movements. The trail could also be divided around power poles or other existing features in order to eliminate the need for adding bollards. This configuration works particularly well with traffic signal poles that incorporate user-activated crosswalk signals.

At the same time, it should be acknowledged that bollards or medians by themselves do not serve as effective deterrents to trail access by motorcycles and smaller all-terrain vehicles (ATVs), which can be a significant nuisance in some areas while also being illegal per City Ordinance. Some years ago, a common solution involved the placement of specially-designed bicycle gates or wheelchair-accessible chicanes across trails to exclude such vehicles. Today, however, the consensus seems to be that such measures are more of a nuisance for legitimate users; especially bicyclists. Instead, enforcement and user vigilance seem to be fairly effective at keeping unauthorized uses to a minimum, at least on more heavily-used trails.

Figure 15: Divided Trail Access with Median



5. Fencing & Railings

Design Standards

Figure 16, below, provides criteria for appropriate application of various railing types.

Figure 16: Railing Warrants

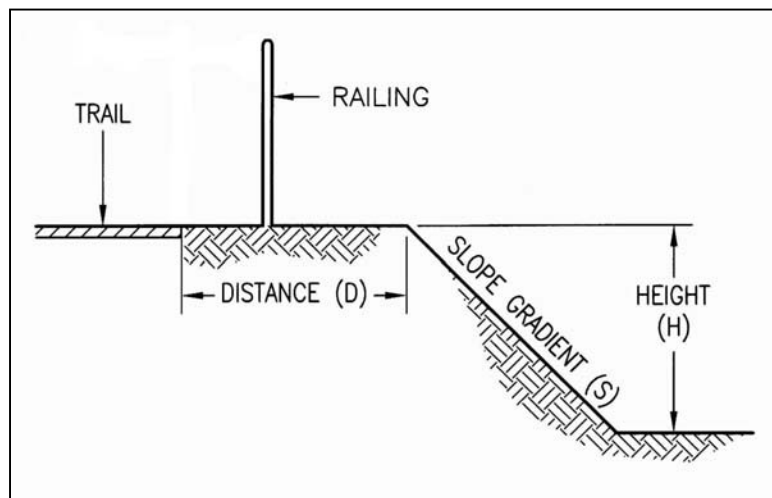

DISTANCE (D)	SLOPE GRADIENT (S)	HEIGHT (H)	RAILING TYPE
10' or further	any	any	None
5'-10'	3H:1V or flatter	any	None

5'-10'	3H:1V to 1H:1V	12' or more	2-Bar
5'-10'	1H:1V to vertical	6' or more	2-Bar
5' or closer	3H:1V to 2H:1V	6' or more	2-Bar
5' or closer	2H:1V to 1H:1V	4' or more	2-Bar
3'-5'	1H:1V to vertical	1.5' – 4'	4-Bar / 6-Bar
3'-5'	1H:1V to vertical	4' or more	Barrier
3' or closer	1H:1V to vertical	1.5' or more	Barrier

Design Considerations & Guidelines

Railings

Safety-Protection railings should be used in situations where trails cross, or are adjacent to, drop-offs, steep slopes, hazardous drainage facilities, or other conditions where the trail user would be ill advised to leave the trail. Railings usually take the form of two-, four-, or six-bar steel pipe railings, depending on the severity of the conditions behind the railing. In cases where extremely hazardous conditions exist along a trail a barrier railing should be used. Barrier railings are those with spaces of six inches or less (or three inch, maximum, openings to comply with U.S. Consumer Product Safety Commission (CPSC) guidelines near playgrounds or other areas frequented by small children). Railings are preferred over fencing in such situations because steel pipe is inherently stronger than most fencing. Railings also present a smoother surface than fencing, which often facilitates recovery if a cyclist wanders off the trail (i.e. brushing against a railing would typically be less catastrophic than catching a handlebar end in a fence mesh).



Post and wire fence.



Open boundaries can be used where users may be entering or existing the trail.

Fencing

Fencing along trails serves two purposes: access control and/or screening. Access control fencing usually consists of wire mesh (e.g. field fence), multiple individual wire strands (high-tensile fencing), or simply a single strand of cable suspended between posts (the aptly named “post-and-cable barrier”). Screen fencing, on the other hand, can be comprised of a wide range of materials, but should conform to three main criteria:



- Screen fencing should not be totally opaque; rather it should provide for limited or indirect visibility to and from the trail corridor (e.g. offset “shadow-box” pickets), ~~for safety reasons~~.
- Materials should be strong enough to withstand impacts from trail users in the event of unintentional contact (for instance, vinyl fencing, while decorative, may not be capable of supporting a horse, or even a cyclist, if the fence is hit with any force).
- Fencing along trails should not contain any sharp edges or corners which could serve as snag points or otherwise cause injury to trail users.

6. Managing Multiple Users

Trails that experience high levels of use, particularly by a variety of user types, may become overcrowded and ~~unsafe-undesirable~~ for some users. The City should consider widening a high-use trail where feasible; otherwise, treatments such as separating bicycle and pedestrian areas, pavement markings and etiquette signs can improve sharing the trail.

Design Standards

- Stripe a centerline. See guidelines below for specifics.
- Separate bicycle and pedestrian areas where feasible.
- Barrier separation – vegetated buffers or barriers, elevation changes, walls, fences, railings and bollards.
- Distance separation – differing surfaces.
- Install Park and Recreation Department typical trail etiquette signage also known as the “yield to” sign.
- In Major Public Open Space areas, trailheads should have regulation signage as well as the Open Space Division’s trail etiquette or “yield to” signage.

Design Considerations & Guidelines

Centerline striping shall be used to encourage users to stay on a particular side of the trail. Use of thermoplastic material shall be used. The line shall be colored yellow and dashed using 3 foot long skips and 9 foot spacing between dashes. Refer to AASHTO for recommendations when solid center stripes should be used such as on turns or curves. Centerline striping is particularly beneficial in the following circumstances:

- For heavy volumes of bicycles and/or other users,
- On curves with restricted sight distance, and
- On unlighted paths where nighttime riding is expected.
- Differing surfaces suitable to each user group foster visual separation and clarity of where each user group should be. A dirt track can draw runners, equestrians, and walkers to reduce conflicts with cyclists. When trail corridors are constrained, the approach is often to locate the two different trail surfaces side by side with no separation.

The MUTCD contains information about centerline striping.

7. Signage

Development of a consistent signage system is an important element in the creation of a unified and recognizable trail system in metropolitan Albuquerque. Signage can be grouped broadly into two categories: regulatory and informational. Regulatory signage includes warnings, regulations, and directives applicable to trail use in general (Stop, No Motor Vehicles, Trail Etiquette, etc.), while informational signage would refer to a signage package specific to a particular trail and location, providing information such as the trail name (especially at designated trailheads), connections to other trails or facilities (through maps or directional arrows), and distances to key destinations. In an effort to expand trail accessibility, these signs also often include information such as trail length, grades, cross slopes, and obstacles which may be encountered (see Trail Difficulty Rating System on page 6).

Design Considerations & Guidelines

Regulatory signage should be placed where most visible and effective, and should be grouped, where practical and appropriate, to minimize the number of posts (potential obstacles). In some cases, free-standing signs may be replaced by pavement markings, for the same reasons. (A specific example would be to replace “Stop Ahead” signs with the same message painted on the trail surface. See Pavement Markings discussion below.) Sizing and placement should be in accordance with the most recent version of the Federal Highway Administration’s Manual on Uniform Traffic Control Devices (MUTCD) Part 9, Bicycle Facilities. However, the City Parks and Recreation Department has developed a few signs that will give Albuquerque’s paved multi-use trail network its own sense of community and style. See [Figure 20 on page 227](#) for images of the signs the Parks and Recreation Department has implemented since 2013.

Trail signage has been designed with a standardized mounting system and graphic medium which can be easily modified or replaced as the trail system grows. Using the same design scheme throughout the entire Trail Network will help users understand that the network is a large system. For example, if you are on a trail on the west side of the City and see the specific green/blue general regulatory/informational sign as in Figure 17 of this Plan, you will also see this same sign on a trail that is part of the network on the east side of the City. However, creativity and customization of trail-specific information signage is encouraged in addition to having the “network specific” regulatory signage in order to develop individual identities for each trail facility.

Pavement Markings

In general, pavement markings supplement or reinforce the regulatory signage, and are comprised of striping, text, and/or stenciled figures. Centerline striping shall be used to help define directions of travel or separate different user groups on multi-purpose trails and be yellow per AASHTO’s recommendations, while solid white edge striping gives trail users visual reinforcement of the limits of the trail surface, which is particularly valuable in low light conditions (especially if a potentially

hazardous condition exists beyond the edge of the trail). Text is generally intended to convey warnings of changing conditions ahead, although it is sometimes used in place of or in addition to vertical regulatory signage (such as “Yield” signs). Figures usually take the form of arrows or other symbols, or may be used to designate portions of the trail for different modes of travel.

Design Considerations & Guidelines

Striping along a trail should be consistent, as any change in color, thickness or width can be perceived as an indication of an expected change. An example of this would be changing from dashed to solid striping on sharp curves which require cyclists to slow down (as described in the Trail Alignment section above).

Placement of text on the pavement, rather than on post-mounted signs, can reduce potential vandalism and/or graffiti targets; however, they are more easily overlooked, and are easily obscured by snow or wind-blown debris. Therefore, critical signage such as “Stop” signs should still be provided on posts alongside the trail.

Both AASHTO and MUTCD provide additional guidance on striping trail facilities.

Figure 1719: Examples of Centerline Markings for Trails

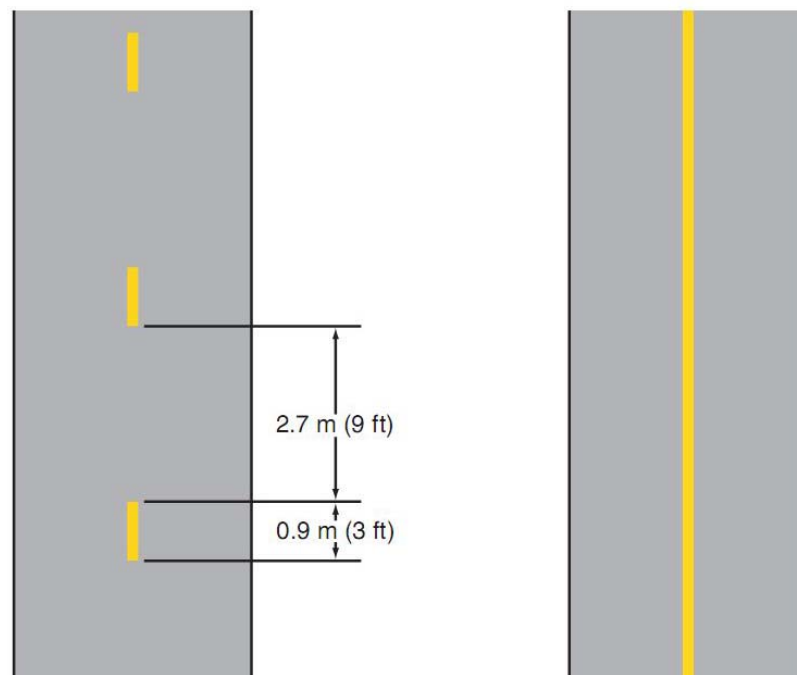

8. Trail Heads & Amenities

Trailheads (7.C.8.a)

Major trailheads should include automobile and bicycle parking, trail information (kiosks including maps, user guidelines and regulations, wildlife information, etc.), garbage receptacles and if possible on a

location by location basis; restrooms and water fountains. Minor trailheads can provide a subset of these amenities.

Good access to a path system is a key element for its success. Trailheads (formalized parking areas) serve the local and regional population arriving to the path system by car, transit, bicycle or other modes. Trailheads provide essential access to the shared-use path system and include amenities like parking for vehicles and bicycles, restrooms (at major trailheads) and posted maps.

All areas of newly designed or newly constructed and altered portions of existing trails connecting to designated trailheads or accessible trails should comply with the most recent and stringent ADA regulations. However, the guidelines do recognize that often the natural environment will prevent full compliance with certain technical provisions. The accessibility audits that the Parks and Recreation Department is working on that started in 2013 will provide an idea of what needs to or can be done to help make trail heads more accessible if and when possible.

Design Considerations & Guidelines

- AASHTO Guide for the Development of Bicycle Facilities. Regulatory Negotiation Committee on Accessibility Guidelines for Outdoor Developed Areas.

Trailhead Parking (7.C.8.b)

One of the City’s goals is to provide a trail network which offers ready access to and from all parts of the city, thereby enabling a reduction in automobile usage. Nonetheless, due to gaps in that developing system, as well as simple human nature, the fact remains that many people do, and will continue to use vehicles to get to the trails. As a result, it is necessary to provide parking wherever possible at trailheads and other major access points along the City’s trail network.

Design Considerations & Guidelines

At a minimum, parking should be provided for cars, with additional spaces provided for horse trailers at trails likely to see equestrian usage. The size/capacity of each parking area should be determined in consultation with the Parks and Recreation Department, and should be based upon projected usage of the trail. Design of the lots should follow parking guidelines set forth in the Development Process Manual (DPM). Parking lots serving accessible trails should have be designed to current ADA standards for parking lots.

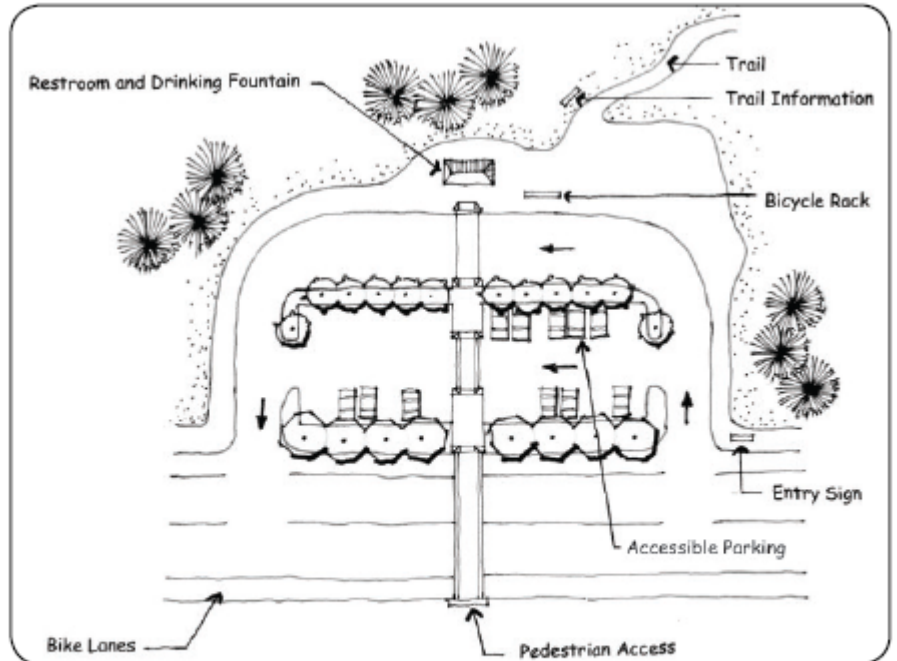

Example major trailhead.

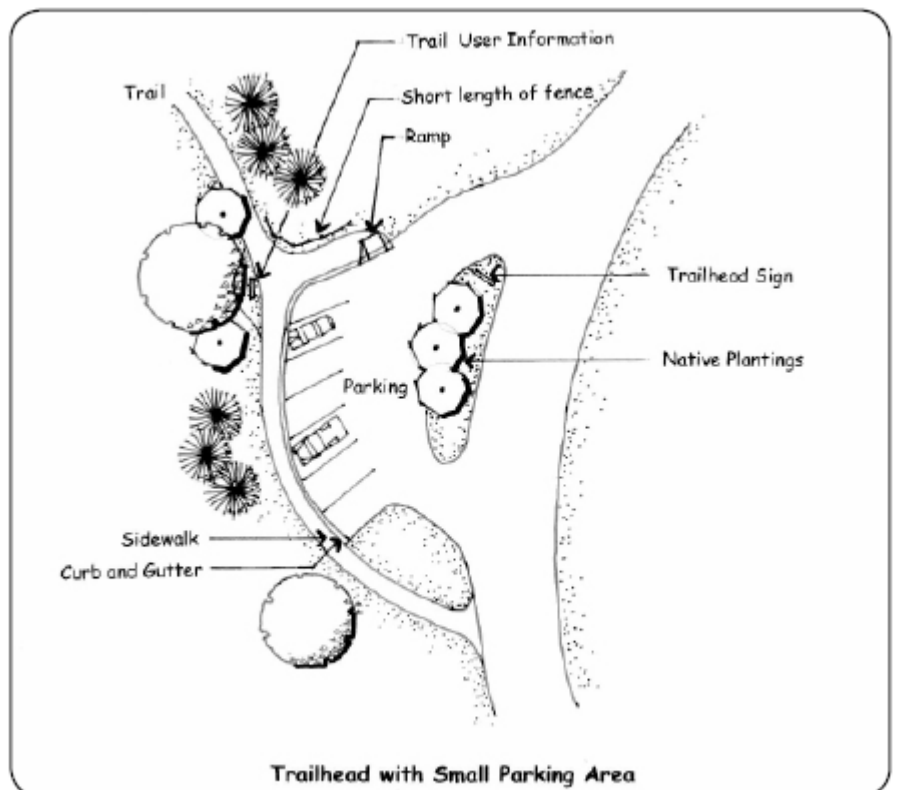

Example minor trailhead.

Amenities (7.C.8.c)

The provision of amenities such as benches and/or tables, trash receptacles, lighting, water fountains, shade structures, industrial type vandal resistant bicycle pumps, and even restrooms tends to make trail use more enjoyable, especially on longer trails. Trail-related amenities can range from minor to major, both in terms of initial installation costs and long term maintenance issues. A major trail improvement might include a restroom facility with a water fountain, as well as benches, bicycle rack, and a trash receptacle. These major amenities should typically be provided in areas with high traffic and, preferably, overlapping uses (e.g. where a trail passes through a park or other public gathering area) in order to maximize return on the investment. Minor improvements, on the other hand, might include benches (or even sitting-height boulder groupings) or trash receptacles, alone or in combination, situated at intervals along the trail. Shade structures – always welcome in the Southwest climate – and directional signage packages fall in the mid-range of the amenity scale.



Recommended pedestrian-scale lighting.

Lighting may be used for visual accent, as well as providing additional security in areas of concern, such as tunnels or other isolated locations. Fixtures should be vandal resistant and should be placed where they most effectively illuminate the trail (or key features within the corridor), without shining in trail users' eyes. They should also be designed and/or located in such a way as to shield nuisance light and minimize impact on adjacent properties. AASHTO provides additional recommendations for lighting in its Guide for the Development of Bicycle Facilities. For the 50 Mile Activity Loop amenities and other information, please refer to that specific Plan.

Design Considerations & Guidelines

Development of trail amenities should follow a conscious plan whereby major amenities are grouped in nodes at key locations, while minor amenities are consistently found along the length of each trail. Styles of amenities should be compatible with adjacent development or closely allied with other amenities found along the length of the trail, in a thematic arrangement. Materials for benches, trash receptacles, tables, and such, must be of durable materials and should be designed (or coated) for easy graffiti removal. Introduction of bicycle pumps used to inflate soft or flat tires will start in 2014. Use of recycled materials is encouraged wherever possible. Coordination with the City's Park Management Division is also encouraged during the material selection process, in order to ensure that maintenance issues are adequately addressed.

Landscaping (7.C.8.d)

Design Considerations & Guidelines

Landscaping along trails typically will fall into one of two categories: revegetation or enhancement. At a minimum, disturbed land within trail corridors should be re-seeded with native grasses (and wildflowers, where appropriate) according to Section 1012 of the City Standard Specifications. Those specifications list two generic seed mixes (for sand or clay soils) which may be used city-wide, with the condition that the shrub component (four-wing saltbush, etc.) be eliminated from seeding alongside recreational trails unless more than 5 feet away from edge of trail (however, the inclusion of xeric shrubs in the seed mix may be desirable for slope stabilization in areas of significant cut or fill). As an alternative to those generic mixes, trail developers may use a more site-specific mix, specified by the project landscape architect, Planner, or in consultation with the City Open Space Division. The addition of wildflower seed to a revegetation mix will provide color and seasonal interest to the trailside, and is particularly effective where the seeding can take advantage of any available supplemental water (e.g. sprinkler overspray from adjacent properties, collected storm water, etc.). Specifically where goat heads (puncture vine) are present or a nuisance, native plants that can out-compete the goat heads should be considered.

More intensive “enhancement” landscaping may be appropriate for high use areas; perhaps at an important trailhead, through a neighborhood development, or in conjunction with a major trail amenity/improvement as identified above. The viability of such landscaping is dependent upon the availability of water and electricity (or alternative power) for an irrigation system, and the establishment of a maintenance agreement with the City Parks Department or a private entity, prior to implementation.

Regardless of the type of landscaping considered, shoulder and clear-zone requirements (as identified earlier in the Trail Dimensions section) shall be followed. Native seeding should be kept back two feet from the edge of the trail (unless it is strictly grasses), in most cases, to allow for the graded, compacted shoulders. Trees are encouraged along trails for the shade that they provide; however, they should be planted at least 6-10 feet back from the edge of trail (to maintain the three-foot clear zone at maturity), and further, if possible, to minimize root damage to the trail surface. Likewise, shrubs should be located such that their branches do not interfere with the trail as they mature. Plant materials in general should be selected for people- and trail-friendly characteristics: thorny plants, trees which tend to drop messy fruit/seeds/pods (which could affect surface traction), and heavy pollen-producers should not be used alongside trails. Native, non-invasive, low water use trees whose roots go downward rather than outward are highly recommended and encouraged next to shared-use paths.

Safety & Visibility (7.C.8.e)

In addition to design factors such as stopping sight distances and trail widths, **safe**-trail design must also take into consideration geographical and environmental factors such as local weather conditions, location (surroundings), and visibility. There is usually a strong correlation between a trail user's sense of **safety-security** and the level of visibility, both into and out from the trail. Therefore, trail designers should strive to maintain a balance between the privacy of adjacent landowners, and **safety-security** concerns of trail users. **Safety and s**Security concerns on a trail can be addressed through Crime Prevention through Environmental Design (CPTED) guidelines.

Crime Prevention through Environmental Design (CPTED)

The four principles of CPTED are:

- Natural surveillance – maintaining sight lines and visibility to deter criminal activities.
- Natural access control utilizes fences, lighting, signage and landscape to clearly define where people and vehicles are expected to be.
- Territorial reinforcement – use physical designs such as pavement treatments, landscaping and signage to develop a sense of proprietorship over the trail.
- Maintenance - if graffiti or vandalism occurs and is not repaired replaced right away, it can send the message that no one is watching or that no one cares.

Design Considerations & Guidelines

Design considerations for maximizing visibility include location, height, and type of fencing (see Access Control section below); clear lines of sight into and through tunnels, underpasses, and bridges; elimination of blind corners at intersections and other locations; and the addition of lighting in appropriate areas.

Weather-related **safety**-design consists primarily of maximizing solar orientation to minimize dangers from ice and snow accumulation. In some cases, protection from potentially gusty winds may be appropriate for open, exposed stretches of trail. Discussion of potential **safety issues-hazardous conditions** related to storm water runoff is contained in the Drainage section below.



Rest stops should provide garbage receptacles to minimize littering.



Surveillance from nearby buildings and pedestrian-scale lighting can increase shared-use path safety.

Privacy of adjacent property owners

- Encourage the use of neighborhood friendly fencing and also planting of landscape buffers.
- Clearly mark path access points.
- Post path rules that encourage respect for private property.
- Strategically placed lighting.

Unwanted vehicle access

- Utilize landscaping to define the corridor edge and path, including earth berms or boulders.
- Use bollards at intersections as needed and as outlined in various bollard assessments, future policies, and AASHTO.
- Pass a motorized vehicle prohibited ordinance and sign the path.
- Create a Trail Watch Program and encourage citizens to photograph and report illegal vehicle use of the corridor. Authorized vehicles are not considered “illegal” vehicle trespass.
- Lay the shared-use path out with curves that allow bike/pedestrian passage but are uncomfortably tight for automobile passage

Litter and dumping

- Post rules encouraging pack it in/pack-it-out practices.
- Place garbage receptacles at trailheads.
- Strategically placed lighting, utilizing light shields to minimize unwanted light in adjacent homes.
- Manage vegetation to allow visual surveillance of the path from adjacent properties and from roadway/path intersections.
- Encourage local residents to report incidents as soon as they occur.
- Remove dumpsites as soon as possible.

Trespassing

- Clearly distinguish public path right-of-way from private property through the use of vegetative buffers and the use of good neighbor type fencing.
- Post rules encouraging respect for property.

Local on-street parking

- Designate residential streets as parking for local residents only to discourage user parking.
- Place “no outlet” and “no parking” signs prior to path access points.
- Accessible parking should be provided when feasible.

Crime

- Manage vegetation to ensure visibility from adjacent streets and residences.
- Place lights strategically and as necessary.
- Place benches and other amenities at locations with good visual surveillance and high activity.
- Provide mileage markers every 1/4 mile and clear directional signage for orientation.

- Create a “Trail Watch Program” involving local residents.
- Encourage proactive law enforcement on the trail.

Vandalism

- Select benches, bollards, signage and other site amenities that are durable, low maintenance and vandal resistant.
- Respond through removal or replacement.
- Keep a photo record of all vandalism when possible and turn it over to local law enforcement.
- Encourage local residents to report vandalism.
- Create a Trail Watch Program and maintain good surveillance of the corridor.
- Involve neighbors in trail projects to build a sense of ownership.
- Place amenities in well used and visible areas.

Visibility

There is usually a strong correlation between a trail user’s sense of safety-security and the level of visibility, both into and out from the trail. Therefore, trail designers should strive to maintain a balance between the privacy of adjacent landowners, and safety-security concerns of trail users.

Design considerations for maximizing visibility include:

- the location, height, and type of fencing (see Access Control section);
- clear lines of sight into and through tunnels, underpasses, and bridges;
- elimination of blind corners at intersections and other locations; and
- addition of lighting in appropriate areas.

Community Involvement with Safety on the to Make Trails a Better Place

Creating a safe-secure trail environment goes beyond design and law enforcement and should involve the entire community. The most effective and most visible deterrent to illegal activity on Albuquerque’s trail system will be the presence of legitimate path users. Getting as many “eyes on the corridor” as possible is a key deterrent to undesirable activity.

- **Good access to the path** - Access ranges from providing conveniently located trailheads along the trail to encouraging the construction of sidewalks to accommodate access from private developments adjacent to the trail. Access points should be inviting and signed so as to welcome the public onto the trail.
- **Good visibility from neighbors** - Neighbors adjacent to the trail can potentially provide 24-hour surveillance of the trail and can become Albuquerque’s biggest ally. Though some screening and setback of the path is needed for privacy of adjacent neighbors; complete blocking out of the trail from neighborhood view should be discouraged. This eliminates the potential of neighbors’ “eyes on the trail” and could result in a “tunnel effect” on the trail.

- **High level of maintenance** - A well-maintained trail sends a message that the community cares about the public space. This message alone will discourage undesirable activity along the trail.
- **Programmed events** - Community events along the trail will help increase public awareness and thereby attract more people to use the trail. Neighbors and residents can help organize numerous public events along the path which will increase support for the path. Events might include a day-long path clean up or a series of short interpretive walks led by long-time residents or a park naturalist.
- **Adopt-a-trail Program** - Nearby businesses, community institutions and residential neighbors often see the benefit of their involvement in trail development and maintenance. Businesses and developers may view the trail as an integral piece of their site planning and be willing to take on some level of responsibility for the trail.
- **Trail Watch Program** - Partnering with local and county law enforcement, a trail watch program would provide an opportunity for local residents to become actively involved in crime prevention along Albuquerque's trail system. Similar to Neighborhood Watch programs, residents are brought together to get to know their neighbors and are educated on how to recognize and report suspicious activity. Although this section is related to ~~safety~~ better awareness, trail watch programs do not solely need to be tied to crime prevention. Many people can report fun items in trail watch reports such as different wildlife and bird sightings and other nature specific items such as interesting native vegetation as well as where noxious weeds are located.

DE. General Intersection Design Guidelines

A wide variety of intersection treatments exist, which provide safe-better crossing for bicyclists and pedestrians. Treatments specific to particular facility types were previously discussed. This section addresses general guidelines for crossings.

1. High-Visibility Crosswalk Techniques

Additional treatments can be used to increase visibility of the crosswalk at high-use locations and in locations with high use from school children, elderly pedestrians or pedestrians with disabilities.

Flasher Warning Sign

Flashing warning signs increase the visibility of a crossing by calling attention to the pedestrian crossing location. They can be continuous, timed for rush hours or activated by a pedestrian push-button. MUTCD Chapter 4L provides information about flashing beacons.



Flashing warning sign.

Raised Median (Non-standard treatment)

A median can eliminate grade changes from the pedestrian path and give pedestrians greater prominence as they cross the street. Raised crosswalks should be used only in limited cases where a special emphasis on pedestrians is desired such as at a mid-block crossing. Review on case-by-case basis.



Raised medians require drivers to slow down.

Design Considerations & Guidelines

- Use detectable warnings at the curb edges to alert vision-impaired pedestrians that they are entering the roadway.
- Approaches to the raised crosswalk may be designed to be similar to speed humps, or they may be designed so they do not have a slowing effect (such as on emergency response routes).
- Use post mounted pedestrian crosswalk signs placed on the median and on the right side of the roadway for each approach.



In-street yield to pedestrian signage.

In-Street “Yield to Pedestrians” Signs and Flashers

In-street “Yield to Pedestrian” signs are flexible plastic paddle signs installed in the center of a roadway to enhance a crosswalk at uncontrolled crossing locations. In-pavement flashers may be appropriate on undivided roadways in densely developed areas that do not offer median refuges for crossing pedestrians. See MUTCD Section 2B.12 In-Street and Overhead Pedestrian Crossing Signs.

In-Roadway Lights

In-roadway lights may be used at marked crosswalks to provide additional warning. They are actuated by the pedestrian and flash for a designated amount of time before turning off. See MUTCD Section 4N.02 In-Roadway Warning Lights at Crosswalks for additional information.

- United States Access Board. (2007). Public Rights-of-Way Accessibility Guidelines (PROWAG).
- MUTCD

Marked Crosswalks

2. Minimizing Conflict with Automobiles

Separating pedestrians and motor vehicles at intersections improves ~~safety and~~ visibility.

Design Considerations & Guidelines

Parking Control

- Parking control improves visibility in the vicinity of the crosswalk. Parking is prohibited within all intersections and crosswalks unless otherwise signed. At “T” and offset intersections, where the boundaries of the intersection may not be obvious, this prohibition should be made clear with signage.
- In areas where there is high parking demand (as determined by a Traffic Engineer), parking for compact vehicles may be allowed within “T” or offset intersections and on either side of the crosswalk. At these locations, signs will be placed to prohibit parking within the designated crosswalk areas and additional enforcement should be provided, particularly when the treatment is new.
- Parking shall not be allowed within any type of intersection adjacent to schools, school crosswalks and

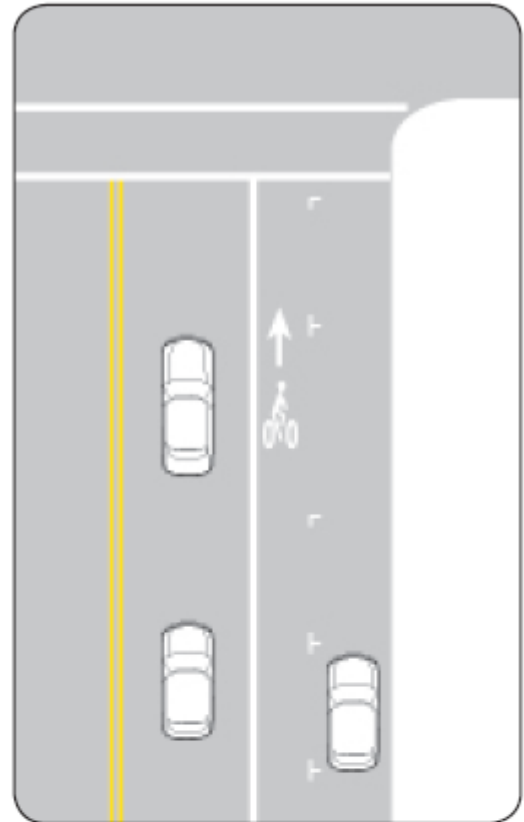

Crosswalks should always be kept clear of on-street parking.



Advance stop bars alert motorists of pedestrians.

parks. This includes “T” and offset intersections.

- Installation of parking signage to allow and/or prohibit parking within any given intersection will occur at the time that the parking control section is undertaking work at the intersection.

Advance Stop Bars

Advance stop bars increase pedestrian comfort ~~and safety~~ by stopping motor vehicles well in advance of marked crosswalks, allowing vehicle operators a better line of sight of pedestrians and giving inner lane motor vehicle traffic time to stop for pedestrians. Pedestrians feel more comfortable since motor vehicles are not stopped adjacent to the crosswalk. The multiple threat of motor vehicles is reduced, since vehicles in the inner travel lane have a clearer line of sight to pedestrians entering the sidewalk. Without an advance stop bar, the vehicle in the outer lane may stop for the pedestrian, but the vehicle in the inner lane proceeds, increasing the possibility of a vehicle-pedestrian conflict.

Advanced stop bars should be used:

- On streets with at least two travel lanes in each direction.
- Prior to a marked crosswalk
- In one or both directions of motor vehicle travel
- Recommended 30 feet in advance of the crosswalk.
- A “Stop Here for Pedestrians” sign must accompany the advance stop bar.

United States Access Board. (2007). Public Rights-of-Way Accessibility Guidelines (PROWAG).

Pedestrian Hybrid Beacon

Figure 4F-3. Sequence for a Pedestrian Hybrid Beacon

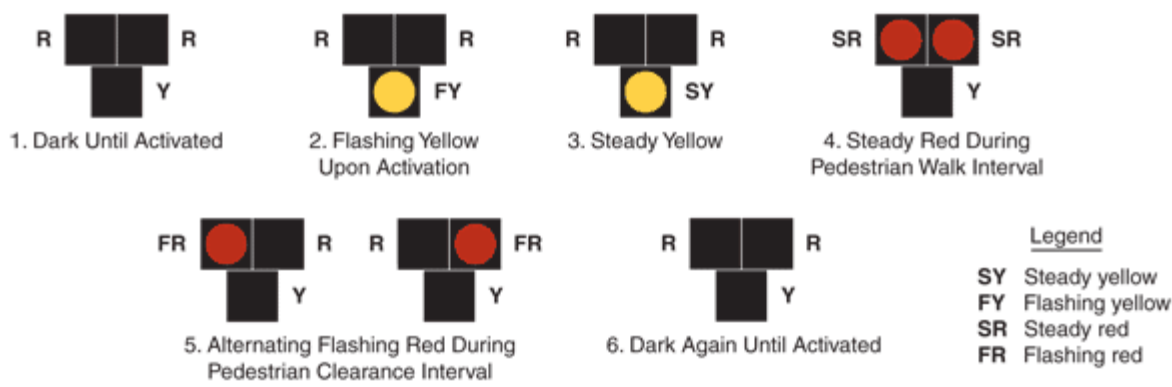

Sequence for a pedestrian hybrid beacon (MUTCD Figure 4F-3).

Guidance from the MUTCD Section 4F. Pedestrian Hybrid Beacons:

- The pedestrian hybrid beacon should be installed at least 100 feet from side streets or driveways that are controlled by a STOP or YIELD sign.

- Parking and other sight obstructions should be prohibited for at least 100 feet in advance of and at least 20 feet beyond the marked crosswalk, or site accommodations should be made through curb extensions or other techniques to provide adequate sight distance.
- The installation should include suitable standard signs and pavement markings.
- If installed within a signal system, the pedestrian hybrid beacon should be coordinated.



Pedestrian hybrid signal; also called HAWK signals (High-Intensity Activated Crosswalk).

Design Considerations & Guidelines

A pedestrian hybrid beacon may be considered for installation to facilitate pedestrian crossings at a location that does not meet traffic signal warrants (see MUTCD Chapter 4C) or at a location that meets traffic signal warrants but where a decision is made to not install a traffic control signal.

The beacon signal consists of a traffic signal head with a red-yellow-red lens. The unit is off until activated, then the signal phasing is:

- The signal flashes yellow to warn approaching drivers.
- A solid yellow advises drivers to prepare to stop.
- The signal changes to a solid red and a WALK indicator is shown.
- The beacon signal converts to an alternating flashing red, allowing the drivers to proceed after stopping at the crosswalk, while the bicyclist or pedestrian is shown the flashing DON'T WALK signal.



Scramble signals allow cyclists to cross a intersection diagonally.

Scramble Signals (Non-standard treatment)

Scramble signals can be used at intersections with frequent vehicle/bicycle conflicts and/or at intersections experiencing high bicycle turning movements (especially left turns that force bicyclists to cross vehicle traffic). Scramble signals provide a simultaneous “All Red” phase for motorists and a green phase dedicated for bicycle/pedestrian movements that enables non-motorized users to cross an intersection using their desired travel path (straight or diagonal).

Scramble signals have been used successfully in Davis, Calif.; Honolulu, Hawaii; and Portland, Ore.

Guidance

- MUTCD Section 4F. Pedestrian Hybrid Beacons

- Bureau of Highway Operations (2010) HAWK Pedestrian Signals: A Survey of National Guidance, State Practice and Related Research
<http://on.dot.wi.gov/wisdotresearch/database/tsrs/tsrhawksignals.pdf>
- National Cooperative Highway Research Program (2006). Improving Pedestrian Safety at Unsignalized Crossings, Report 562, 2006.
http://onlinepubs.trb.org/onlinepubs/nchrp/nchrp_rpt_562.pdf

3. Accommodating Bicyclists at Intersections

At signalized intersections, cyclists should be able to trigger signals when cars are not present. Requiring cyclists to dismount to press a pedestrian button is inconvenient and requires the cyclist to merge in into traffic at an intersection. It is particularly important to provide bicycle actuation in a left-turn-only lane where cyclists regularly make left turn movements.

Design Considerations & Guidelines

Loop Detectors

- Bicycle-activated loop detectors are installed within the roadway to allow the presence of a bicycle to trigger a change in the traffic signal. This allows the cyclist to stay within the lane of travel and avoid maneuvering to the side of the road to trigger a push button.
- Most demand-actuated signals in Albuquerque currently use loop detectors, which can be attuned to be sensitive enough to detect any type of metal, including steel and aluminum.
- Current and future loops that are sensitive enough to detect bicycles should have pavement markings to instruct cyclists how to trip them, as well as signage (see right).

Detection Cameras

Video detection cameras can also be used to determine when a vehicle is waiting for a signal. These systems use digital image processing to detect a change in the image at the location. Cameras can detect bicycles, although cyclists should wait in the center of the lane, where an automobile

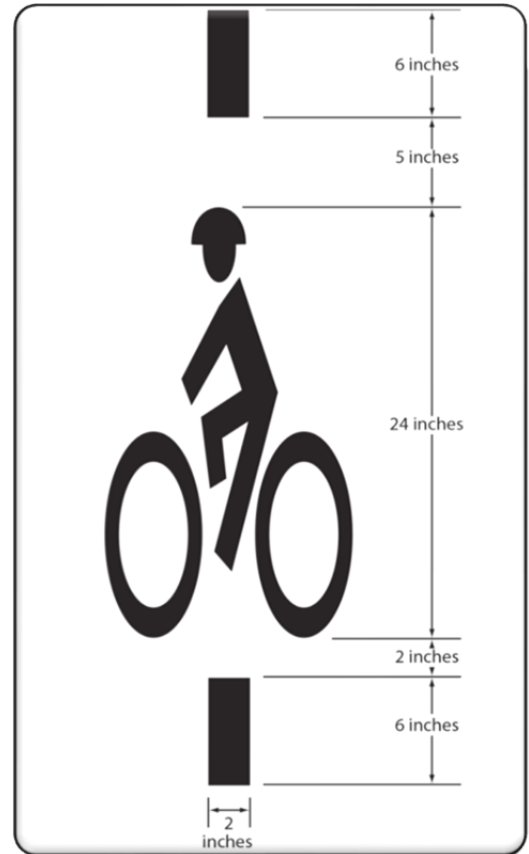

Instructional Sign (MUTCD Sign R10-15).

would usually wait, in order to be detected. Video camera system costs range from \$20,000 to \$25,000 per intersection.

Detection cameras are currently used for cyclists in the City of San Luis Obispo, Calif., where the system has proven to detect pedestrians as well.

Remote Traffic Microwave Sensor Detection (RTMS) (Non-standard treatment)

RTMS is a system developed in China that uses frequency modulated continuous wave radio signals to detect objects in the roadway. This method is marked with a time code which gives information on how far away the object is. The RTMS system is unaffected by temperature and lighting, which can affect standard detection cameras.

Push Buttons

A pushbutton is a four-foot pedestal pole next to the curb for a cyclist to actuate the signal. Push buttons should only be used in locations without right turn bays and can be used with or without bike lanes.

Guidance

- Additional technical information is available at:
www.humantransport.org/bicycledriving/library/signals/detection.htm
- ITE Guidance for Bicycle—Sensitive Detection and Counters: <http://www.ite.org/councils/Bike-Report-Ch4.pdf>

4. Trail Intersections and Crossings

At-grade path/roadway crossings generally will fit into one of four basic categories:

- Type 1: Marked/Unsignalized-Unprotected crossings include trail crossings of residential, collector and sometimes major arterial streets or railroad tracks.
- Type 1+: Marked/Enhanced - Unsignalized intersections can provide additional visibility with flashing beacons and other treatments.
- Type 2: Route Users to Existing Signalized Intersection - Trails that emerge near existing intersections may be routed to these locations, provided that sufficient protection is provided at the existing intersection.
- Type 3: Signalized/Controlled - Trail crossings that require signals or other control measures due to traffic volumes, speeds and trail usage.
- Type 4: Grade-Separated Crossings - Bridges or under- crossings provide the maximum level of safety-security but also generally are the most expensive and have right-of-way, maintenance and other public safety-security considerations.

Design Considerations & Guidelines

At-grade crossings are the most widespread method of accommodating trail/ roadway intersections. As with separate-use trail facilities, the high costs and right-of-way needs associated with grade-separated

crossings often preclude their use. Even when built, grade-separated crossings often go unused, for a variety of reasons. Experience has shown that most individuals prefer a direct route of travel, and will not detour even a short distance to use a grade-separated structure, if there are other at-grade possibilities, even if the more direct route saves only a small amount of time. However, at-grade crossings are also the most dangerous, because of one simple fact: trail users and motor vehicles must share the same space. The relative safety-security of any at-grade crossing is dependent on a number of factors, and the ability of the trail user to quickly evaluate those factors and determine an adequate “window of opportunity” for making a safe crossing. Those factors include:



An offset crossing forces pedestrians to turn and face the traffic they are about to cross.

- Walking, riding, or rolling speed (which varies widely among trail users)
- Vehicular traffic speed and volume
- Number of lanes to be crossed
- Traffic signal intervals (where applicable)
- Demographics such as gender and age

Since most, if not all, of these factors are beyond the control of the trail designer, at-grade crossings should be laid out so as to maximize the opportunities for trail users to safely-adequately negotiate them. Design features such as median refuges, smooth surface transitions at curb ramps and pavement joints, adequate sight distances, and warning signs should be incorporated wherever possible. (Under current policies, crosswalks are not recommended, except at signalized intersections and past studies have shown that they might give trail users a false sense of security and encourage them to cross without regard to traffic. However, newer studies and discussions show that mid-block crossings and other at-grade crossings not at intersections may be beneficial to the user if they are striped. This typically is more useful for crossings with fewer lanes.)The AASHTO Guide deals fairly extensively with design issues related to trail intersections.

While at-grade crossings create a potentially high level of conflict between path users and motorists, well-designed crossings have not historically posed a safety-problem for path users. This is evidenced by the thousands of successful paths around the United States with at-grade crossings. In most cases, at-grade path crossings can be properly designed to a reasonable degree of safety-protection and can meet existing traffic and safety-standards.

Evaluation of path crossings involves analysis of vehicular and anticipated path user traffic patterns, including:

- Vehicle speeds

- Traffic volumes (average daily traffic, peak hour traffic).
- Street width
- Path user profile (age distribution, destinations served)
- Sight distance

Crossing features for all roadways include warning signs both for vehicles and path users. Consideration must be given for adequate warning distance based on vehicle speeds and line of sight, with visibility of any signing absolutely critical. Catching the attention of motorists jaded to roadway signs may require additional alerting devices such as a flashing light, roadway striping or changes in pavement texture. Signing for path users must include a “STOP” sign and pavement marking, sometimes combined with other features such as bollards.

Guidance

The proposed intersection approach that follows is based on established standards, published technical reports and experiences from cities around the country.

Summary of Path/Roadway At-Grade Crossing Recommendations

Roadway Type	Vehicle ADT ≤ 9,000			Vehicle ADT > 9,000 to 12,000			Vehicle ADT > 12,000 to 15,000			Vehicle ADT >>15,000		
	30	35	40	30	35	40	30	35	40	30	35	40
2 Lanes	1	1	1/1+	1	1	1/1+	1	1	1	1	1/1+	+/3
3 Lanes	1	1	1/1+	1	1/1+	1/1+	1/1+	1/1+	1/1+	1/1+	1+/3	1/3
Multi-Lane (4+) w/raised median***	1	1	1/1+	1	1/1+	1+/3	1/1+	1/1+	1+/3	1+/3	1+/3	1+/3
Multi-Lane (4+) w/o raised median***	1	1/1+	1+/3	1/1+	1/1+	1+/3	1+/3	1+/3	1+/3	1+/3	1+/3	1+/3

*General Notes: Crosswalks should not be installed at locations that could present an increased risk of pedestrians, such as where there is poor sight distance, complex or confusing designs, a substantial volume of heavy trucks, or other dangers, without first providing adequate design features and/or traffic control devices. Adding crosswalks alone will not make crossing safer, nor will they necessarily result in more vehicles stopping for pedestrians. Whether or not marked crosswalks are installed, it is important to consider other pedestrian facility enhancements (e.g. raised median, traffic signal, roadway narrowing, enhanced overhead lighting, traffic-calming measures, curb extensions), as needed, to improve the safety of the crossing. These are general recommendations; good engineering judgment should be used in individual cases for deciding which treatment to use.

For each pathway-roadway crossing, an engineering study is needed to determine the proper location. For each engineering study, a state review may be sufficient at some locations, while a more in-depth study of pedestrian volume, vehicle speed, sight distance, vehicle mix, may be needed at other sites.

**Where the speed limit exceeds 40mph marked crosswalks alone should not be used at un-signalized locations.

***The raised median or crossing island must be at least 4ft (1.2m) wide and 6ft (1.8m) long to adequately serve as a refuge area for pedestrians in accordance with MUTCD and AASHTO guidelines. A two-way center turn lane is not considered a median.

1 = Type 1 Crossing. Ladder-style crosswalks with appropriate signage should be used.

1/1+ = With the higher volumes and speeds, enhanced treatments should be used, including marked ladder style crosswalks, median refuge, flashing beacons and/or in-pavement flashers. Ensure there are sufficient gaps through signal timing, as well as sight distance.

1+/3 = Carefully analyze signal warrants using a combination of Warrant 4, Pedestrian Volume or 5, School Crossing (depending on school presence) and Equivalent Adult Unit (EAU) factoring (see MUTCD, Chapter 4). Make sure to project pathway usage based on future potential demand. Consider Pelican, Puffin, or Hawk signals in lieu of full signals. For those intersections not meeting warrants or where engineering judgment or cost recommends against signalization, implement Type 1 enhanced crosswalk markings with ladder style crosswalks, median refuge, flashing beacons and/or in-pavement flashers. Ensure there are sufficient gaps through signal timing, as well as sight distance.

Type 1: Marked/Unsignalized Crossings

A marked/unsignalized crossing (Type 1) consists of a crosswalk, signage and often no other devices to slow or stop traffic. The approach to designing crossings at mid-block locations depends on an evaluation of vehicular traffic, line of sight, path traffic, use patterns, vehicle speed, road type and width and other safety-related issues such as proximity to schools. The following thresholds recommend where unsignalized crossings may be acceptable:

Maximum traffic volumes:

- ≤9,000-12,000 Average Daily Traffic (ADT) volumes.
- Up to 15,000 ADT on two-lane roads, preferably with a median.
- Up to 12,000 ADT on four-lane roads with median.

Maximum travel speed:

- 35 mph.

Minimum line of sight:

- 25 mph zone: 155 feet
- 35 mph zone: 250 feet
- 45 mph zone: 360 feet

Design Considerations & Guidelines

If well-designed crossings of multi-lane higher-volume arterials over 15,000 ADT may be unsignalized with features such as a combination of some or all of the following: excellent sight distance, sufficient crossing gaps (more than 60 per hour), median refuges and/or active warning devices like flashing beacons or in-pavement flashers. These are referred to as “Type 1 Enhanced” (Type 1+). Such crossings would not be appropriate; however, if a significant number of schoolchildren used the path.

Furthermore, both existing and potential future path usage volume should be taken into consideration.

On two-lane residential and collector roads below 15,000 ADT with average vehicle speeds of 35 mph or less, crosswalks and warning signs (“Path Xing”) should be provided to warn motorists, and stop signs and slowing techniques (bollards/geometry) should be used on the path approach. Curves in paths that orient the path user toward oncoming traffic are helpful in slowing path users and making them aware of oncoming vehicles. Care should be taken to keep vegetation and other obstacles out of the sight line for motorists and path users. Engineering judgment should be used to determine the appropriate level of traffic control and design.

On roadways with low to moderate traffic volumes (<12,000 ADT) and a need to control traffic speeds, a raised crosswalk may be the most appropriate crossing design to improve pedestrian visibility ~~and safety~~. These crosswalks are raised 3 inches above the roadway pavement (similar to speed humps) to an elevation that matches the adjacent sidewalk. The top of the crosswalk is flat and typically made of asphalt, patterned concrete or brick pavers. Brick or unit pavers should be discouraged because of potential problems related to pedestrians, bicycles and ADA requirements for a continuous, smooth, vibration-free surface. Detectable warning strips are needed at the sidewalk/street boundary so



Type 1 Crossing

that visually impaired pedestrians can identify the edge of the street.

Type 2: Route Users to Existing Signalized Intersection

Crossings within 250 feet of an existing signalized intersection with pedestrian crosswalks are typically diverted to the signalized intersection for safety purposes to lessen potential hazards. For this option to be effective, barriers and signing may be needed to direct shared-use path users to the signalized crossings. In most cases, signal modifications would be made to add pedestrian detection and to comply with ADA.

Type 3: Signalized/Controlled Crossings

New signalized crossings may be recommended for crossings that meet pedestrian, school or modified warrants, are located more than 250 feet from an existing signalized intersection and where 85th percentile travel speeds are 40 mph and above and/or ADT exceeds 15,000 vehicles. Each crossing, regardless of traffic speed or volume, requires additional review by a registered engineer to identify sight lines, potential impacts on traffic progression, timing with adjacent signals, and capacity-and safety.

Mid-block Crosswalk

Mid-block crossings provide a crossing opportunity where there is no intersection. At controlled mid-block crossing locations, crosswalks are marked where there is a demand for crossing and there are no nearby marked crosswalks. At uncontrolled crossing use FHWA report HRT-04-100 as guidance of when to mark a crosswalk. Mid-block crosswalks should always be accompanied with pavement markings and warning signs to inform drivers of the approaching crosswalk.

Type 4: Grade-separated Crossings

Grade-separated crossings may be needed where existing bicycle/pedestrian crossings do not exist, where ADT exceeds 25,000 vehicles and where 85th percentile speeds exceed 45 mph. Safety-The potential for crashes is a major concern with both overcrossings and under-crossings. In both cases, shared-use path users may be temporarily out of sight from public view and may have poor visibility themselves. Under-crossings, like parking garages, have the reputation of being places where crimes



Type 3 Crossing.



Mid-block crosswalk.

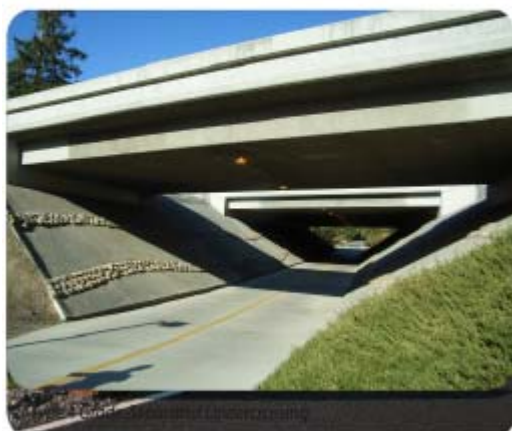

Landscaping improves the walking and bicycling experience, and can deter vandalism.

occur. Most crime on shared-use paths, however, appears to have more in common with the general crime rate of the community and the overall usage of the shared-use path than any specific design feature.

Design and operation measures are available which can address shared-use path user concerns. For example, an undercrossing can be designed to be spacious, well-lit, equipped with emergency cell phones at each end and completely visible for its entire length prior to entering. Under-crossings should include lighting, particularly where nighttime security is a potential issue. AASHTO recommends average maintained horizontal illumination levels of 5 lux to 22 lux, depending on the location.

Other potential problems with under-crossings include conflicts with utilities, drainage, flood control and maintenance requirements. Overcrossings pose potential concerns about visual impact and functional appeal, as well as space requirements necessary to meet ADA guidelines for slope.

Grade-separated crossings take two forms: above-grade (bridges), or below-grade (tunnels/underpasses/notches). The decision to use one or the other is driven primarily by topography, although availability of right-of-way and cost of the structure ~~and safety~~ must also be taken into account. In either case, many of the same basic design criteria should be applied to make the crossing as ~~safe and~~ efficient as possible:

- Align the crossing structure with connecting trail facility, to the extent possible while minimizing detours and/or switchbacks– see discussion under At-Grade Crossings above.
- Maintain good visibility into – and preferably all the way through – the structure.
- Provide adequate clear width to carry trail tread plus shoulders across or through the structure, if possible. In a tunnel situation, additional “elbow room,” such as that afforded by elliptical culverts, helps to alleviate the sense of claustrophobia sometimes associated with narrower underpasses.
- Minimize approach ramp grades. It is important to construct the ramps at a 5% or less grade to help accommodate future ADA regulations and makes the structure more easily accessible by wheelchairs, bicycles, and eliminates the need for intermediate landings.

The City shall evaluate the opportunities for both an underpass and overpass at every crossing location prior to making the determination about which grade-separated crossing option to select.

5. Pedestrian and Cycling Supportive Site Design

The DPM requires that, “All new roadways which are legal for bicycle use should be designed and constructed under the assumption that they will be used by bicyclists.”

The DPM provides the following guidance for accommodating bicycles on new streets:

a) Development of Bike Lanes on New or Reconstructed Roadways

Bike lanes should be provided on all new or reconstructed arterial and collector roadways.

Recommended minimum widths for bicycle lanes are as follows:

- 5 feet, measured from painted edgeline to edge of gutter, on roadways with posted speed limits of 40 mph or greater.
- 4 feet, measured from painted edgeline to edge of gutter, on roadways with posted speed limits of 35 mph or less.

Bike lanes shall be flush with roadside gutters and should be marked in accordance with the MUTCD and AASHTO guidelines. Future roadway improvements should retain existing bike lanes, including intersection approaches where additional turn-lanes may be constructed.

The DPM also states that, “In new residential or commercial developments adjacent to bikeways, contiguous walls or fences should provide breaks for paved bicycle access which link the development to the bikeway system. Access(es) should be delineated on the sketch plat, preliminary plat and/or site development plan as appropriate.”

6. Bike Routes to Transit

~~Safe-Secure~~ and easy access to bicycle parking facilities is necessary to encourage commuters to access transit via bicycle. Bicycling to transit reduces the need to provide expensive car parking spaces, mitigates peak-hour congestion and promotes active, healthy lifestyles.

Providing bicycle routes to transit helps combine the long-distance coverage of bus travel with the door-to-door service of bicycle riding. Transit use can overcome large obstacles to bicycling, including distance, hills, riding on busy streets, night riding, inclement weather and breakdowns. Providing bicycle access to transit and space for bicycles on buses can increase the feasibility of transit in lower-density suburban areas where transit stops are beyond walking distance of many residences. People are often willing to walk only a quarter-mile to half-a-mile to a bus stop, while they might bike as much as two or more miles to reach the bus station. As the majority of bus stops do not provide long-term, secure parking options for bicycles, most people who ride to a bus stop will want to bring their bicycle with them on the transit portion of their trip.

The local bicycle network should connect to transit stations, particularly higher-volume hubs that provide bicycle parking. The TCRP report, Bicycle and Transit Integration also recommends bicycle paths from neighboring communities that are shorter in length than roadways, which is particularly important in areas with a disconnected street pattern. Signage on these routes should be clearly visible, using the bicycle symbol for bike routes and parking facilities.

High-visibility crosswalks and mid-block crossings are often appropriate treatments ~~to provide safer for~~ effective bicycle and pedestrian access to bus stops, particularly at high-usage transit stops. If a bus stop

is located mid-block, adequate crossing treatments should be provided based on the level of traffic on the roadway. All transit riders will need to cross the street to access or leave the bus stop.

EF. Wayfinding

Wayfinding needs of on-street and multi-use trail users are similar but the location identification infrastructure differs. On-street bikeways benefit from an existing street name, address and signing system. This type of system currently does not exist for the multi-use trail network. The City's multi-use trails are named but a mile marker system means of location identification and signing needs to be established. This section will address the improvements for a wayfinding of the on-street and multi-use trail facilities. The ability to navigate through a city is informed by landmarks, natural features and other visual cues. Signs throughout the city can indicate to pedestrians and bicyclists their direction of travel, location of destinations and travel time/distance to those destinations.

1. On-Street

Bike Routes

Bike routes should be identified using the bike route sign D11-1. Placement should be at the beginning and end of the bike routes, using the M4-14 and M4-6 plaques (Figure 1). Where routes split or shift to an intersecting street, advanced turn arrows (M4 series) and directional arrows (M5 series) shall be used to indicate the change in direction. The D11-1 sign can be placed occasionally along the bike route to help in wayfinding. Other signs that provide additional route identity are the bicycle warning sign W11-1 with the Share-the-road plaque W16-1P (Figure 2) and bicycle may use full lane R4-11 (Figure 3). These signs can help remind motorists and cyclists of the presence of a bicycle facility.

Pavement markings can be used to provide awareness of the presence of the bicycle facility as well as wayfinding guidance.

Pavement markings Sharrows (Figure 4) and bike route "pavement direction indicators" or bike blazes (Figure 5) can be effective and durable additions to help guide the cyclist along their route. The bike blaze can be used to indicate changes in direction of the bike route.

Bike Lanes

Bike lanes are separate travel lanes for use by bicycles. The bike lanes are marked using a lane edge stripe between the motor vehicle lane and the bike lane and include bike lane symbols and bike lane signs (R3- 17). Where bike lanes change direction or at the junction with another bike lane, directional arrow sign plaques (M4 and M5 series) should be included. These simple additions to the built environment can provide adequate guidance for the cyclist to aid in route identification. Figure 9B-4 in chapter 9 of the MUTCD shows a selection of guide signs and plaques that can be used to inform bicyclists of bike route direction changes and to confirm route direction, distance and destination.

Bicycle Boulevards

Bike boulevards are roadways in which bicyclists share the pavement with motor vehicles, but the facility is optimized in favor of the bicycle. Bicycle boulevards are characteristically slower than residential streets to the extent that posted speed limits are non-typical (18 mph vs. 25 mph). The non-typical speed limit is intended to call attention to the bike boulevard's posted speed being different from a normal roadway.

The City recently developed a series of signs and pavement markings to provide identification for the bicycle boulevards. The color and logo of these signs are unique to the Bicycle Boulevard and provide identification, guidance and wayfinding for the cyclist alerting the motorist to the unique character and operations of the bicycle boulevard (Figure 6).

On-Street Signage Guidelines

Signage for on-street bikeways can serve both wayfinding and safety-informational purposes including:

- Helping to familiarize users with the bicycle network.
- Helping users identify the best routes to destinations .
- Helping overcome a “barrier to entry” for people who are not frequent cyclists or pedestrians.
- Visually cue motorists that they are driving along a bike route and should use caution.
- Including mileage and travel time estimates minimize the tendency to overestimate the amount of time it takes to travel by bicycle (Figure 8).

Identifying Destinations for Signage

Destinations for on-street signage can include:

- On-street bikeways (regional or local)
- Commercial centers
- Regional or local parks and trails
- Public transit sites
- Civic or community destinations (hospitals and schools)
- Area destinations (e.g., cities, downtowns or neighborhoods)



Figure 6a



Figure 7 - Wayfinding signage concept.



Figure 8 - Wayfinding that includes distance and time can address misperceptions about time and distance.

Placement Standards and Techniques

Too many road signs clutter the right-of-way. Signs should be placed at key locations to and along bike routes, including:

- Confirmation signs designate bikeways to bicyclists and drivers.
- Turn signs indicate where a bikeway turns from one street onto another street.
- Decision signs mark the junction of two or more bikeways and include destinations and associated directional arrows.

Additional recommended guidelines include:

- Place the closest destination to each sign in the top slot, allowing the nearest destination to fall off the sign and subsequent destinations to move up as the bicyclist approaches.
- Use pavement markings to help reinforce routes and directional signage. Markings, such as bicycle boulevard symbols (Figure 9), bike blaze and sharrow may be used in addition to signs along bike routes and can help cyclists navigate difficult turns in route.

Pavement Markings

In general, pavement markings supplement or reinforce the regulatory signage, and are comprised of striping, text, and/or stenciled figures.

- Centerline striping shall be used to help define directions of travel or separate different user groups on multipurpose trails and be yellow per AASHTO's recommendations, while solid white edge striping gives trail users visual reinforcement of the limits of the trail surface, which is particularly valuable in low light conditions (especially if a potentially hazardous condition exists beyond the edge of the trail).
- Text is generally intended to convey warnings of changing conditions ahead, although it is sometimes used in place of vertical regulatory signage (such as "Yield" signs). Figures usually take the form of arrows or other symbols, or may be used to designate portions of the trail for different modes of travel.
- Striping along a trail should be consistent, as any change in color, thickness or width can be perceived as an indication of an expected change. An example of this would be changing from dashed to solid striping on sharp curves which require cyclists to slow down (as described in the Trail Alignment section above).
- Placement of text on the pavement, rather than on post-mounted signs, can reduce potential vandalism and/or graffiti targets; however, they are more easily overlooked, and are easily



Figure 9 - Bicycle Boulevard pavement marking.

obscured by snow or wind-blown debris. Therefore, critical signage such as “Stop” signs should still be provided on posts alongside the trail.

Guidance

Both AASHTO and MUTCD provide additional guidance on striping trail facilities.

2. Multi-use Trails

Development of a consistent signage system is an important element in the creation of a unified and recognizable trail system in metropolitan Albuquerque. Signage can be grouped broadly into two categories: regulatory and informational. Regulatory signage includes warnings, regulations, and directives applicable to trail use in general (Stop, No Motor Vehicles, Trail Etiquette, etc.), while informational signage would refer to a signage package specific to a particular trail and location, providing information such as the trail name (especially at designated trailheads), connections to other trails or facilities (through maps or directional arrows), and distances to key destinations. In an effort to expand trail accessibility, these signs also often include information such as trail length, grades, cross slopes, and obstacles which may be encountered (see Trail Difficulty Rating System on [page 6](#)).

Wayfinding can be a challenge for most trail users. A system needs to be established to provide effective wayfinding for the trail users and location identification for emergency responders.

Trail identification

Multi-use trails are typically identified by name, usually coinciding with the major feature which they parallel such as an arroyo, highway or geographical location. Examples of these are the Bear Canyon, I-40 trail and Paseo del Bosque multi-use trails. Knowing where you are on these trails can be difficult due to lack of an addressing system. A logical system needs to be established that provides the trail user with their location and direction of travel. Multi-use trails shall follow the following conventions with regards to direction and location.

Trail Name

- Officially recognized trails should all have names. Trail names should be memorable, informative, and linked to specific trail sections.
- Names are more useful when easier to recall. In general, words are more memorable than numbers. More specific names are better than generic ones (“Sandia Crest Trail” rather than “Long Trail”). Sets of trail names should be easy to distinguish (avoid sets like “Tramway Trail”, “Tramway Hills Trail,” “Tramway Heights Trail” etc). Using both Spanish (“Paseo de las Montañas”) and English (“North Diversion Channel Trail”) adds to distinctiveness and honors New Mexico’s multilingual heritage (in part).
- Trail names can be useful when they provide information on trail location, trail connections and character or function of the trail. Many of the paved trails in the Albuquerque area are named for the roads or watercourses that they parallel. This helps locate where they are, but can be

problematic when trails or trail sections only follow a part of a road or watercourse that runs a long distance. Names like “Mariposa Linear Park” and “Emery Trail” show links to Mariposa Basin, and the Michial Emery trailhead respectively.

- Separate trail sections should receive distinct names, even if along same road or watercourse. Sections can be distinguished by suffixes such as “east, central, west” or other appropriate divisions. Foothills trail 365 should be divided into “North” and “South” sections.

Trail direction and mile marker

- The trail names shall be posted on trail signage at street and trail intersections. Stencils on paved trails offer a defacement-resistant alternative to traditional post-mounted, eye-level signage.
- Multi-use trails that have a predominantly south/north alignment shall have a mile marker designation that begins at mile zero at the southern terminus of the trail. If there are plans to extend the trail towards the south the mile marker shall begin at the future southerner terminus of the planned extension. The mile markers shall increase along the trails alignment in the northerly direction.
- Multi-use trail that have a predominantly west/east alignment shall have a mile marker designation that begins at mile zero the existing western terminus of the trail. If there are plans to extend the trail to the west the mile marker shall being at the future western terminus of the planned extension. The mile markers shall increase along the trails alignment in the easterly direction.
- When posting mile marking information shall be shown to the nearest 1/10th of a mile in decimal format. Whole number mile marks shall use a decimal point followed by a zero.

Trail location

- Locations on a trail shall be identified by the distance from the beginning terminus of the trail expressed in miles and tenths of miles.

It would be beneficial to the trail users to include on the City’s bike map multi-use trail mile markers at major locations such as trail heads, trail/trail intersections and trail/street intersections. Emergency responders should be aware of the multi-use trail identification system and incorporate it into their dispatching protocol.

Guidance

Trail identification/location marking and wayfinding can be comprised of signs, trail heads, kiosks, maps and pavement markings. The type of location marking is dependent on the location and anticipated needs of the trail users.

Regulatory Signs

Design Considerations & Guidelines

Regulatory signage should be placed where most visible and effective, and should be grouped, where practical and appropriate, to minimize the number of posts (potential obstacles). In some cases, free-

standing signs may be replaced by pavement markings, for the same reasons. (A specific example would be to replace “Stop Ahead” signs with the same message painted on the trail surface. See Pavement Markings discussion below.) Sizing and placement should be in accordance with the most recent version of the Federal Highway Administration’s Manual on Uniform Traffic Control Devices (MUTCD) Part 9, Bicycle Facilities. However, the City Parks and Recreation Department has developed a few signs that will give Albuquerque’s paved multi-use trail network its own sense of community and style. The following are examples of what the Parks and Recreation Department has implemented since 2013. See [Figure 20, below](#):

Figure 1820: Trail Etiquette Signs



Informational signage should be dealt with on a trail-by-trail basis, developing a logo or theme for each trail, and developing a signage package which reflects that theme. This package has been designed with a standardized mounting system and graphic medium which can be easily modified or replaced as the trail system grows. However, creativity and customization of the trail-specific informational package, post (or alternative mounting) configuration and thematic colors are encouraged, in order to develop individual identities for each trail facility.

Pavement Markings

In general, pavement markings supplement or reinforce the regulatory signage, and are comprised of striping, text, and/or stenciled figures. Centerline striping shall be used to help define directions of travel or separate different user groups on multi-purpose trails and be yellow per AASHTO’s recommendations, while solid white edge striping gives trail users visual reinforcement of the limits of the trail surface, which is particularly valuable in low light conditions (especially if a potentially hazardous condition exists beyond the edge of the trail). Text is generally intended to convey warnings of changing conditions ahead, although it is sometimes used in place of vertical regulatory signage (such as “Yield” signs). Figures usually take the form of arrows or other symbols, or may be used to designate portions of the trail for different modes of travel.

Design Considerations & Guidelines

Striping along a trail should be consistent, as any change in color, thickness or width can be perceived as an indication of an expected change. An example of this would be changing from dashed to solid striping on sharp curves which require cyclists to slow down (as described in the Trail Alignment section above).

Placement of text on the pavement, rather than on post-mounted signs, can reduce potential vandalism and/or graffiti targets; however, they are more easily overlooked, and are easily obscured by snow or wind-blown debris. Therefore, critical signage such as “Stop” signs should still be provided on posts alongside the trail.

Guidance

Both AASHTO and MUTCD provide additional guidance on striping trail facilities.

Signage Location

Trail head

Trail head identification should be used to indicate the terminus of the trail, thus informing users approaching the trail from an intersecting trail and when users are leaving a specific trail to use another trail. The trail head can be as simple as a sign identifying the trail by name or more informative by including additional information, such as the City’s Bike Map, or a map emphasizing the trail and showing the trail length, major destinations and distances and 911 emergency reporting instructions. A kiosk can provide a good location to display this information in addition to trail etiquette educational information and pet waste cleanup stations. Trail appurtenances near the kiosk may also improve user satisfaction and aid in alerting quick moving commuters to the congested quality, which maybe present near the kiosk as shown in the figure at the right.

Mid-trail marking

Mid-trail markings should be placed at 0.5 mile intervals starting at the southern or western trail terminus and shall include the trail name and mile marker. A combination of a pavement marking and sign can be used or pavement marking solely. Pavement markings showing the trail name and mile marker shall be placed on and parallel to the trail centerline using retro-reflective pavement marking utilizing a 4-inch high white letters and numbers. When a sign is used, a single, double-sided sign shall be placed on the right side of the trail in the direction of increasing mileage. The sign shall be a flexible fiberglass composite extending 3 feet above ground displaying the mile marker and optionally the trail name. An example of the mid-trail pavement marking and sign is shown in Figure 11.

Trail/street intersections

Where a multi-use trail intersects a street the trail name, trail mile marker and street name shall be displayed. In addition destination guide signs may be appropriate.

Intersection sign

A post mounted street name sign, similar to a D3-1 with 4-inch initial upper-case letters with 3-inch lower-case letters, shall be located on the right side of the trail near as particle to the edge of the street right-of-way. These signs shall display the trail name and street name. For trails with long names appropriate abbreviations can be used.

Intersection pavement marking

The street name shall be shown using retro-reflective pavement marking in 6-inch high white letters placed perpendicular to the trails centerline approximately 10 feet from the intersection. The trail name and mile marker retro-reflective pavement marking shall be placed on and parallel to the trail centerline using retro-reflective pavement marking using 4-inch high white letters and numbers and should be placed approximately 25 feet before the intersection. Figure 12 shows the preferred layout for trail identification markings.

Trail/trail intersections

Where multi-use trails intersect the trail names and mile markers shall be shown using signs and pavement markings.

Intersection sign

Post mounted signs displaying both trail names, similar to a D3-1 sign with 4-inch initial upper-case letters with 3-inch lower-case letters, shall be located at the intersection. For trail with long names appropriate abbreviations can be used.

Intersection pavement marking

The trail name, for each trail, shall be shown using retro-reflective pavement marking in 4-inch high white letters and numbers. The multi-use trail name and mile marker shall be placed on and parallel to the center line of the trail approximately 25 feet before the intersection. Figure 13 shows the preferred layout for trail identification markings.

FG. Maintenance & Operations

Properly maintaining the City's bikeways and multi-use trail system is vital to the longevity and usefulness of these facilities. This plan addresses issues concerning pavement preservation, sweeping, pavement marking and signs, vegetation control, drainage, crack sealing/filling and a Spot Improvement Program for bikeways and multi-use trails. Recommendations include monitoring the frequency of sweeping requests and the identification of areas that typically require more than the normally scheduled sweeping, puncture vine control using biological and herbicidal methods and proper use of landscape materials next to multi-use trails.

For on-street bikeways, pavement preservation, signs, pavement markings and sweeping are the responsibilities of Street Maintenance Division. Multi-use trail pavement preservation, signs and

pavement markings, vegetation control and sweeping are the responsibilities of Parks and Recreation Maintenance Division.

1. On-Street Bike Facility Maintenance Considerations

Like all roadways, bike lanes, routes, and bike boulevards require regular maintenance. This includes sweeping, maintaining a smooth roadway, ensuring that the gutter-to-pavement transition remains relatively flat and installing bicycle-friendly drainage grates. These considerations are particularly relevant to bike lanes, as cyclists have a narrow corridor to traverse.

Surface

Bicycles are much more sensitive to subtle changes in roadway surface than are motor vehicles. Various materials are used to pave roadways and some are smoother than others. Compaction is also an important issue after trenches and other construction holes are filled. Uneven settlement after trenching can affect the roadway surface nearest the curb where bicycles travel. Sometimes compaction is not achieved to a satisfactory level, and an uneven pavement surface can result due to settling over the course of days or weeks. For more information, see BikeSafe Repetitive/Short-Term Maintenance document: www.bicyclinginfo.org/bikesafe/countermeasure.cfm?CM_NUM=-4

- Ensure that on new roadway construction, the finished surface on bikeways does not vary more than 1/4 of an inch.
- Maintain a smooth surface of all bikeways that is free of potholes.
- Maintain pavement so ridge buildup does not occur at the gutter-to-pavement transition.

Pavement preservation

The surface condition of on-street bicycle facility pavement has a significant effect on the quality of the riding experience. Ride comfort ~~and safety~~ depends on a smooth, crack-free paved surface without longitudinal ridges between pavement lifts or along gutter edges. Longitudinal pavement cracking or separation between adjacent surfaces wider than half an inch can potentially be hazardous, trapping bicycle wheels and causing crashes.

Transverse cracking, while less hazardous than longitudinal cracks, degrades the ride quality. In areas where motor vehicles normally do not travel, such as bike lanes and shoulders, transverse cracking can degrade further resulting over time into ridges along the edges of the crack a condition that cyclist tend to avoid riding on choosing to use the driving lane instead of the designated bike lane or shoulder.

Crack sealing: Crack sealing is used as a first defense against further pavement deterioration because it offers important benefits. Effective crack sealing keeps water from entering and weakening the base or sub-base. It helps preserve the pavement adjacent to the cracks and extends pavement life by minimizing crack growth. Cracks are typically sealed using rubberized hot pour material that can be problematic for cyclists to ride over. Caution should be used when sealing cracks that run in the direction of travel, as this material can cause loss of handling and lead to loss of control of the bicycle. Sealing transverse

cracks often creates a ridge, degrading the ride quality. Crack sealing, shown in Figure 1, should be used as a temporary means of pavement preservation.

Slurry Seal Overlay: A mixture of emulsified asphalt, fine aggregate, mineral filler and water. The slurry seal is placed on the surface of the existing pavement adding $\frac{1}{4}$ of an inch to the pavement thickness.

Micro-Surfacing Overlay: A composition of polymer asphalt emulsion and selected fine aggregate. It is applied cold and can be placed in thicknesses up to 1.5 inches.

Properly applied Slurry Seal and Micro-Surfacing can provide a smooth riding surface extending the pavement life. Care must be exercised to minimize the ridge along the gutter lip at the pavement/gutter interface.

Chip Seal: Chip Seal is an application of a binder in the form of an emulsion or hot spray and an application of an aggregate as close to single size as possible. Chip seal should not be used for bikeways.

Heater Scarification: Heater scarification is a process of heating the surface of the existing pavement with either natural gas fired burners or infrared heaters, scarifying the softened surface with ripper teeth and spraying it with a rejuvenating agent. This material is all mixed together in an auger chamber and leveled with a screed. Pneumatic rollers compact the loose mixture in preparation for the overlay.

Heater Repaving: This process is similar to the heater scarification process. First the pavement is heated, then scarified and a rejuvenating agent is then added and it is mixed. At the same time that this process is performed, a layer of hot mix asphalt is placed over the heated recycled surface. A screed is then used to level the pavement. The pavements are then compacted. The scarification is usually between $\frac{3}{4}$ to $1\frac{1}{2}$ inches deep.

Care must be exercised when using pavement overlays to minimize the ridge along the gutter lip. Examples of pavement overlays with acceptable pavement/gutter interface can be seen in Figure 2 and unacceptable ridge along the gutter lip at the pavement/gutter interface can be seen in Figure 3.

Mill and inlay: Milling of an asphalt concrete pavement surface refers to the mechanical removal of a part of the pavement surface. There are several applications of the milling process. The most common is to remove an unstable surface that exhibits excessive distresses, such as roughness, cracking, rutting or raveling, and reduce pavement build up to eliminate the need to raise drainage structure elevations and to have paved surfaces match gutter elevations. After milling the asphalt pavement surface, a lift of asphalt is placed on the milled surface to provide a new roadway surface. Again, as when using pavement overlays, care must be exercised to minimize the ridge along the gutter lip at the pavement/gutter interface.

Sweeping

Accumulation of debris on streets comes from many different sources. This includes natural sources, such as plan material and road kill; systemic sources, such as debris from adjacent driveways and improperly used landscaping; and human generated debris, such as crash debris, litter and broken glass. Reduction, prevention and management are important in keeping a clean and safe-functional facility. Loose debris on a bicycle facility can cause loss of traction, flat tires and hazardous conditions for the cyclist.

Bicycles have a lower tolerance than motor vehicles for objects on the roadway surface. Broken glass, small gravel, sand and twigs can easily be driven over by most motor vehicles without causing problems. A small object on the roadway can be big problems for bicycles. Those objects can result in an unsuitable riding condition for a bicycle. Additionally, the aforementioned debris tends to migrate from the wheel paths of driving lanes to the bike lane. With this in mind sweeping requirements for bicycle facilities differ from those needed for motor vehicles. The frequency of bicycle facility sweeping may need to be increased over what is normally scheduled for roadways. Gravel and sand coming from an unpaved driveway shown in Figure 4 can easily be driven over by motor vehicles but can cause problems for cyclists. It may be advantageous to collect data on the condition of the bicycle facility during scheduled sweeping and when requests are made for additional sweeping. This data could be used in determining the areas that require more attention, providing supporting data when requesting maintenance budgets and the development of effective bicycle facility sweeping schedules.

Pavement markings

Several methods of pavement marking are available: Paint, hot thermoplastic and preformed plastic. All of these methods have similar requirements for retro-reflectivity and color while the cost and durability depends on the specific type of marking material. Bicycle facility pavement markings should be maintained with emphases on retro-reflectivity, legibility and discoloration. When the pavement markings are determined to be deficient replacement or repainting of the marking is required.

Repaving of a roadway can provide an opportunity for the City to reconfigure the roadway cross-section to include bicycle facilities. In many cases this can be done inexpensively and quickly in the restriping process by including bicycle facilities where feasible. On repaved roadways with bicycle facilities the pavement markings shall be replaced to match the pavement marking configuration as they were prior to the repaving.

Drainage Grates

Drainage grates are located in the gutter area near the curb of a roadway. They typically have slots to drain water into the municipal storm water system. Many grates are designed with linear parallel bars spread wide enough for a tire to become caught so that if a bicycle were to ride on them, the front tire would become caught and fall through the slot. This would cause the cyclist to tumble over the handlebars and sustain potentially serious injuries.

- Require all new drainage grates be bicycle-friendly, including grates that have horizontal slats on them so that bicycle tires do not fall through the vertical slats.
- Consider a program to inventory all existing drainage grates and replace hazardous grates as necessary.



Examples of bicycle-safe drainage grates.

Signs

Signs have a finite life span due to the degradation of the reflectivity and fading and should be replaced when they no longer are legible or meet the retro-reflectivity requirements. Signs that are missing or damaged from graffiti and/or crashes should be cleaned or replaced. Care in cleaning must be exercised as to not degrade the retro-reflectivity of the sign, erase the sign message or change the sign color. In locations where graffiti is more common anti-graffiti coatings on sign faces or sign face materials that can withstand graffiti removal should be considered.

Vegetation control

Encroaching vegetation shall be kept away from the bicycle facility and roadways in general. Vegetation shall not block signs or line of sight at intersections and provide at least 8 feet of vertical clearance above the bicycle facility. Periodic trimming of vegetation, especially when leaves are on the plants, may be required. Mowing of weeds and grasses along the roadway edges should be done before they encroach into the bikeway. Sweeping after mowing may be needed to remove debris from the bikeway.

Drainage

Drainage on roadways with curbs and gutters is normally conveyed along the outside edge of the roadway where the bike lanes typically are. During significant rain events the bike lanes will usually be inundated by the drainage, making them difficult or impossible for cyclist to use. After rain events debris that has accumulated due to runoff will need to be removed from the bicycle facilities (Figure 5). In locations where this happens frequently due to runoff, increased sweeping of the bikeway may be needed and the drainage system should be modified to prevent the debris accumulation. Catch basin grates should be bicycle-[safeready](#) and replaced with the appropriate grate if not.

2. Multi-Use Trails

The burrs of Puncture Vine (known as goat heads) cause flat tires and injure pets and are the single most frequent complaint of trail users regarding on-going maintenance. Other maintenance concerns raised during public meetings and by the advisory groups largely relate to ~~safety~~ potential hazards on the trail: glass, gravel, or other debris on the trails, missing bollards with the collar exposed, plants encroaching on trails or blocking visibility, and asphalt that is cracked and in need of repair or replacement.

Pavement preservation

As asphalt pavement ages, it tends to shrink, creating transverse cracks. Thermal expansion and contraction cause cracks to become wider, creating an unsuitable riding surface. Multi-use trails are typically not susceptible to longitudinal cracking, as the width of the trail allows for it to be paved in a single pass by the asphalt lay-down machine. However, new designs and full depth reclamations shall take care to avoid creating an edge of pavement drop-off of more than 1.5 inches. This can be achieved by using a tapered asphalt section.

Crack sealing: Crack sealing of multi-use trail asphalt pavement is similar to that of the on-street facility. It is the first defense against further pavement deterioration, but it is a temporary measure. Caution should be used when sealing to prevent ridges that are problematic for people using trails. In addition to the rubberized hot pour material, a ridged crack fill for cracks wider than half an inch has been used with limited success. Over time shrinkage of the asphalt pavement can cause the ridged crack fill material to pull away from the crack edges, thus producing another crack (Figure 6). Narrow crack should not be repaired using rigid material (Figure 7) because it will not enter the crack and remain on the pavement surface creating a ridge.

Full Depth Reclamation: (Bomag®) Cold Mix-In-Place-Recycling, Full depth reclamation is an in-situ process that grinds up the existing asphalt pavement and aggregate base course, mixes both together and replaces it back on the sub-grade soil. This homogeneous mixture is then re-compacted and ready for a new asphalt pavement.

Street Maintenance Division, DMD should assist Park Management in determining the most effective methodology for extending pavement life and the two divisions should also explore sharing responsibility for addressing these issues.

Sweeping

Keeping the trail surface clear of debris is important for the ~~safety~~ security and comfort of trail users. Trails should be swept on a scheduled basis and when requested. Locations that historically require more frequent sweeping should be noted and investigated as to what may be causing this problem and fix if practical. Locations that need immediate sweeping (Figure 10) should be reported to the City.

Pavement markings

Generally, trails have a few simple markings (e.g., a yellow center line); however, these should be repainted or replaced when necessary.

Signs

Signs have a finite life span due to the degradation of the reflectivity and fading and should be replaced when they no longer are legible or meet the retro-reflectivity requirements. Signs that are missing or damaged from graffiti and/or vandalism should be cleaned or replaced. Care in cleaning must be exercised, so as to not degrade the retro-reflectivity of the sign, erase the sign message or change the sign color (See Figure 9). In locations where graffiti is more common anti-graffiti coatings on sign faces or sign face materials that can withstand graffiti removal should be considered.

Vegetation control

Trimming: Vegetation shall not block signs or line of sight at intersections and horizontal curves.

Additionally, ground level vegetation shall not protrude beyond the edge of the trail shoulder. Periodic trimming of vegetation especially when leaves are on the plants may be required. Mowing of weeds and grasses along the trail edges should be done before they encroach beyond shoulder of the trail. Sweeping after mowing may be needed to remove debris from the trail surface.

Root Control: Root heave seriously degrades pavements. It is characterized by a sharp hump and cracking along a sporadic path (Figure 10). When the pavement is damaged by root heave the pavement in the immediate area will need replacement along with removal of the offending roots.

Noxious Weed Control

Control of weeds like Puncture Vine (*Tribulus terrestris*), more often referred to as goat heads, can be difficult. There are no quick and lasting solutions. Two methods are currently used by the City with limited success: mechanical and chemical. Two other methods, encouraging native species and biological, should be considered for experimentation.

Mechanical: This involves the cutting and removal of the growing, ground hugging vine. It is a time consuming process that should be performed before the plant's seeds mature. If the cut plants have mature seeds care in handling should be used so as to not drop and distribute the seeds.

Chemical: Park Management has used both pre- and post-emergent herbicides to control goatheads. Effective weed control with chemicals is highly dependent on timing. Other issues related to chemical use include chemical sensitivities of some trail users, proximity of trails to channels or other drainage structures, impacts on beneficial insects, and potential damage to nearby desirable plants. Each of these issues should be considered when developing and implementing a chemical treatment approach.

Approved aquatic herbicides are allowed when a trail is next to a channel or other drainage structure. The post-emergent herbicide Aquamaster (Rodeo) is an approved aquatic pesticide being used by

AMAFCA and MRGCD. Our understanding is that it can be used as needed where there is: bare ground, monotypic stands of goat heads, or spot application is done selectively being careful to avoid natives. Clarification of its usage and proper application procedures should be confirmed with the Pesticide Compliance trainer. NMDOT uses a different herbicide, VistaXRT which they report is both a pre- and post-emergent.

There are pre-emergent herbicides that are effective. Products containing oryzalin, benefin, or trifluralin will provide partial control of germinating seeds. These must be applied late winter to mid-spring prior to germination. After plants have emerged from the soil (post-emergent), products containing 2,4-dichlorophenoxyacetic acid ("2,4-D"), glyphosate and dicamba are effective on puncture vine. Like most post-emergent, they are more effectively maintained when caught small and young. Some people have sensitivities to these herbicidal chemicals and prefer that they be used limitedly or not at all. Temporary warning sign indicating when herbicides are being applied may be helpful to inform the public of their use.

Competition: Good stands of native grasses and plants along the trails significantly reduce the goat head problem. Trail managers broadly agree that if we can get native grasses and other desirable native plants (ones that don't require irrigation and a lot of mowing) established next to the asphalt trails, the use of herbicides can be reduced over time, the weed problem can be abated, and the trails will be more pleasant to users, both aesthetically and practically. Thick stands of native grasses and other herbaceous natives have the added benefit of protecting the trail shoulder from erosion.

However, establishing native grasses and forbs without irrigation is highly dependent on rainfall and other weather variables. The first step is to protect and encourage existing stands of native plants as much as possible during initial construction or reconstruction. Reclamation seeding should be required along newly constructed or rebuilt trails (reference most recent City Standard Specifications for native seeding along trails.) Establishment may require protection from foot traffic. Other management practices impact the health of native vegetation and its ability to out-compete weeds along the trails. These include mowing height (which should be no shorter than 4-6"), mowing frequency (no more than 3 times per year), and minimizing soil disturbance.

Knowledge of plants is critical, allowing for selective control of undesirables, while protecting desirable vegetation. Because establishing native grasses without irrigation is highly dependent on rainfall and other weather variables, the first step is to protect and encourage existing stands of native plants as much as possible during initial construction or reconstruction. Reclamation seeding should be required along newly constructed or rebuilt trails (reference most recent City Standard Specifications for native reseeding along trails).

Biological: Two weevils, *Microlarinus lareynii* and *M. lypriformis*, native to India, France and Italy, were introduced into the United States as bio-control agents in 1961. Both species of weevils are available for

purchase from biological suppliers. Weevils can keep populations in check, but suppression is cyclic and not always effective. Weevils can keep populations in check, but suppression is cyclic and not always effective.

- *Microlarinus lareynii* is a seed weevil that deposits its eggs in the young burr or flower bud. The larvae feed on and destroy the seeds before they pupate, emerge, disperse and start the cycle over again. Its life cycle time is 19 to 24 days.
- *Microlarinus lypriformis* is a stem weevil that has a similar life cycle, excepting the location of the eggs, which includes the undersides of stems, branches and the root crown. The larvae tunnel in the pith where they feed and pupate. Adults of both species overwinter in plant debris. Although the stem weevil is slightly more effective than the seed weevil when each is used alone, the weevils are most effective if used together and the puncture vine is moisture-stressed.

More research is required regarding suitability in our climate. The NMSU Extension Service reported “that Dr. Gerald Nielsen at NM Department of Agriculture released the weevils in a test program in the mid- to late-1960s. The stem weevil failed to establish, apparently. The seed weevil seems widely established but not that impressive.” Extension agents we spoke with are not aware of any successful introductions in NM since that time. The Extension agents also reported having checked with Kerry Bryan, the State Plant Health Director with USDA-APHIS-PPQ. who said, in the event someone wants to bring in their own seed weevils for their use, they need to file a ‘526 form’ which is the official request for approval of interstate shipment of biological agents, beneficials included.

Mulch

Gravel slope stabilization and other mulch ground cover material shall not be placed on steep slopes near the trail. When mulch is used, a minimum two-foot wide shoulder next to the trail’s edge should be kept free of this material. Uncontained mulch on a steep slope will migrate onto the trail creating a hazard for trail users (Figure 12). In locations where mulch has spilled onto the trail, the ground cover material should be replaced with a more stable material, the side slope near the trail re-graded to prevent material from spilling onto the trail or more frequent maintenance be performed at these locations to keep the trail free of debris.

Addressing these issues on private property where there are public trails will require an ordinance change to require different trail design standards related to course gravel adjacent to the trail edge. Stone smaller than a ¼” in diameter or smaller, or stabilized crusher fines are adequate options which preserve a recovery zone and pavement stabilization, a parallel path for pedestrians, and weed/maintenance. Cross reference DPM amendment recommendation in **Chapter 6.B.4**.

Drainage

Drainage on trails is generally less of an issue than street facilities, as trails have a tapered or blunt edge without the confinement of a curb, which confines drainage and thus debris to the pavement. However,

trails typically are designed with tapered shoulders and parallel ditches. Where storm runoff drains off a side slope it should be directed away from the trail. Debris that is deposited on the trail from runoff should be removed as soon as possible (Figure 13). At locations where this occurs frequently, additional trail maintenance will be needed until the drainage problem is corrected.

Test Weed Control Strategies

There is broad agreement that if we can get native grasses and other desirable native plants that don't require irrigation and a lot of mowing established next to the asphalt trails, the use of herbicides can be reduced over time, the weed problem can be abated, and the trails will be more pleasant to users, both aesthetically and practically. However, establishing native grasses and forbs without irrigation is highly dependent on rainfall and other weather variables. The first step is to protect existing stands of native plants as much as possible during initial construction or reconstruction.

We think it worthwhile for Parks Maintenance to consider potential ideas for test sections to try different strategies for weed control/establishment of native grasses and plants in narrow areas along existing trails to be designed and implemented by Park Management personnel or a contractor. These would include various combinations of soil prep (including ways of removing or reducing the existing weed seed bank), seeding of native grasses and forbs, and mulching (principally based on City of Albuquerque reclamation seeding specifications).

Additional thoughts for management after germination:

- Mow high – no shorter than 4-6", no more than 3x per year. If vegetation and grasses in some locations start to crowd into the trail and narrow the clear width for travel, address with alternative mowing schedule.
- Practice selective weed control. Provide basic training in ID and recognition of desirable natives and a few true weed species. Reduce the use of herbicides.
- Protect established desirable grasses, wild flowers and shrubs. Reseed all disturbed areas. Don't scrape to control weeds.

For more information on goat heads, see this [link](#):

<http://www.cabq.gov/planning/documents/GoatheadSynopsisTBFPversion.pdf>