

City of Albuquerque

ADU/ CASITA DRAWING SET



650 SF UNIT

Unit Floorplan Area:

Heated Area: 650 SF
Storage Area: 0 SF
Porch/Patio Area: 200 SF
Total Area: 850 SF

Applicable Code Editions:

2021 NM Residential Building Code
2020 NM Electrical Code
2021 NM Mechanical Code
2021 NM Plumbing Code

IMPORTANT NOTICE: This plan set complies with all applicable technical construction codes in the City of Albuquerque, New Mexico, in effect on December 20, 2023. No warranty or representation of any type is made or intended, implicitly or explicitly, regarding compliance with codes in other jurisdictions.

LAST REVISION DATE: 2/14/2024

SHEET	CITY OF ALBUQUERQUE
1 OF 6	ABQ ADU Model 650 FLAT ROOF

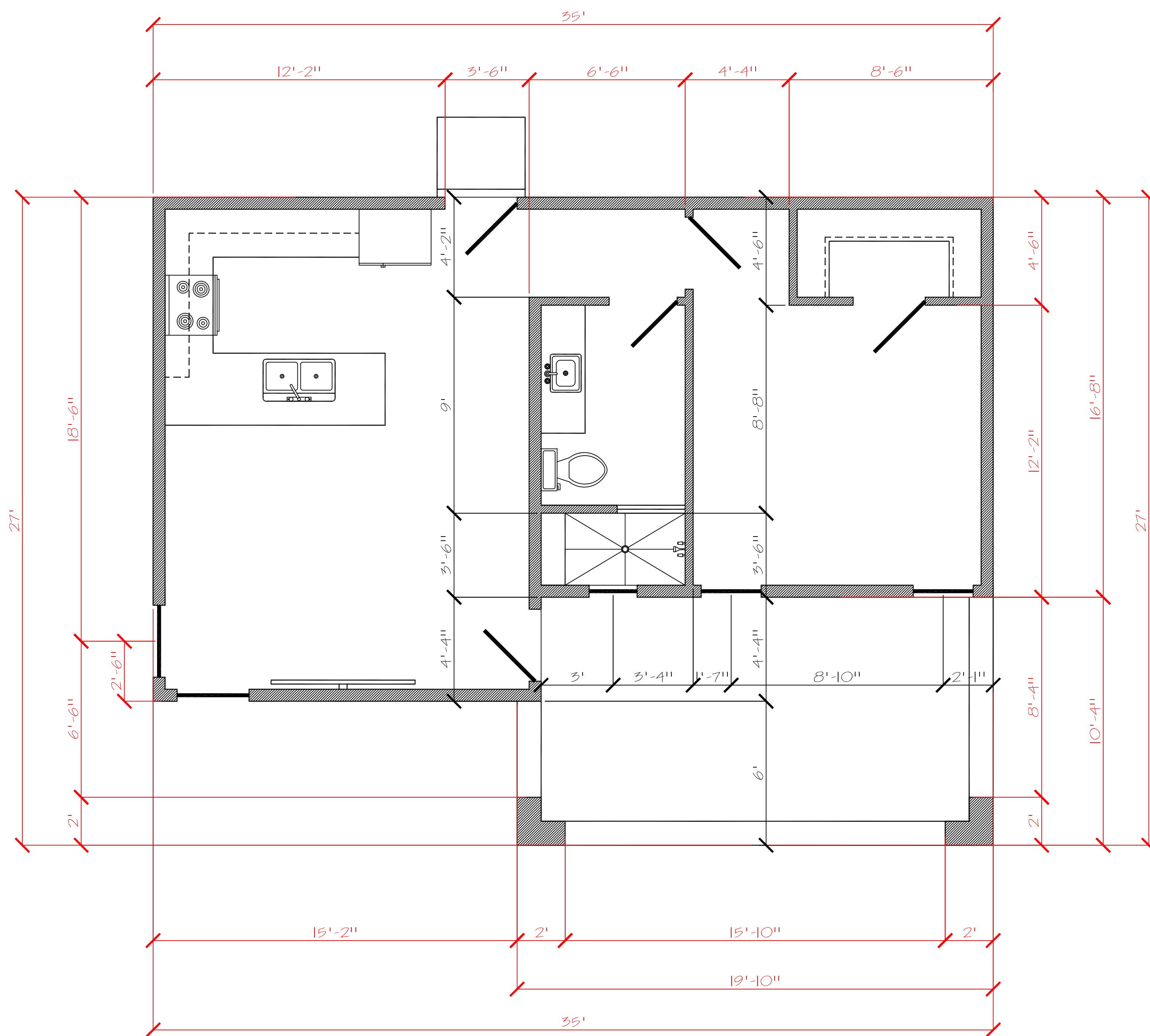

Dimensions
NTS

2021 NM Residential Energy Conservation Code Table R402.1.3, with Climate Zone 4 except Marine	
1. Fenestration U-Factor	0.30
2. Skylight U-factor	0.55
3. Ceiling R-Value	R-49
4. Wood Frame Wall R-Value 2x4 Framed Walls	Per 2021 IECC Table 402.1.3 and NMAC 14.7.6.12, Wood frame wall R-value 30
5. Mass Wall R-Value	R-8 (Exterior), R-13 (Interior)
6. Floor R-Value	R-19
7. Basement Wall R-Value	R-10ci / R-13
8. Slab R-Value & Depth	R-15 / 2ft. Heated Slabs R-10 / 2ft. Unheated Slabs R-5 Under Entire Heated Slab
9. Crawl Spaces R-Value	R-10ci / R-13

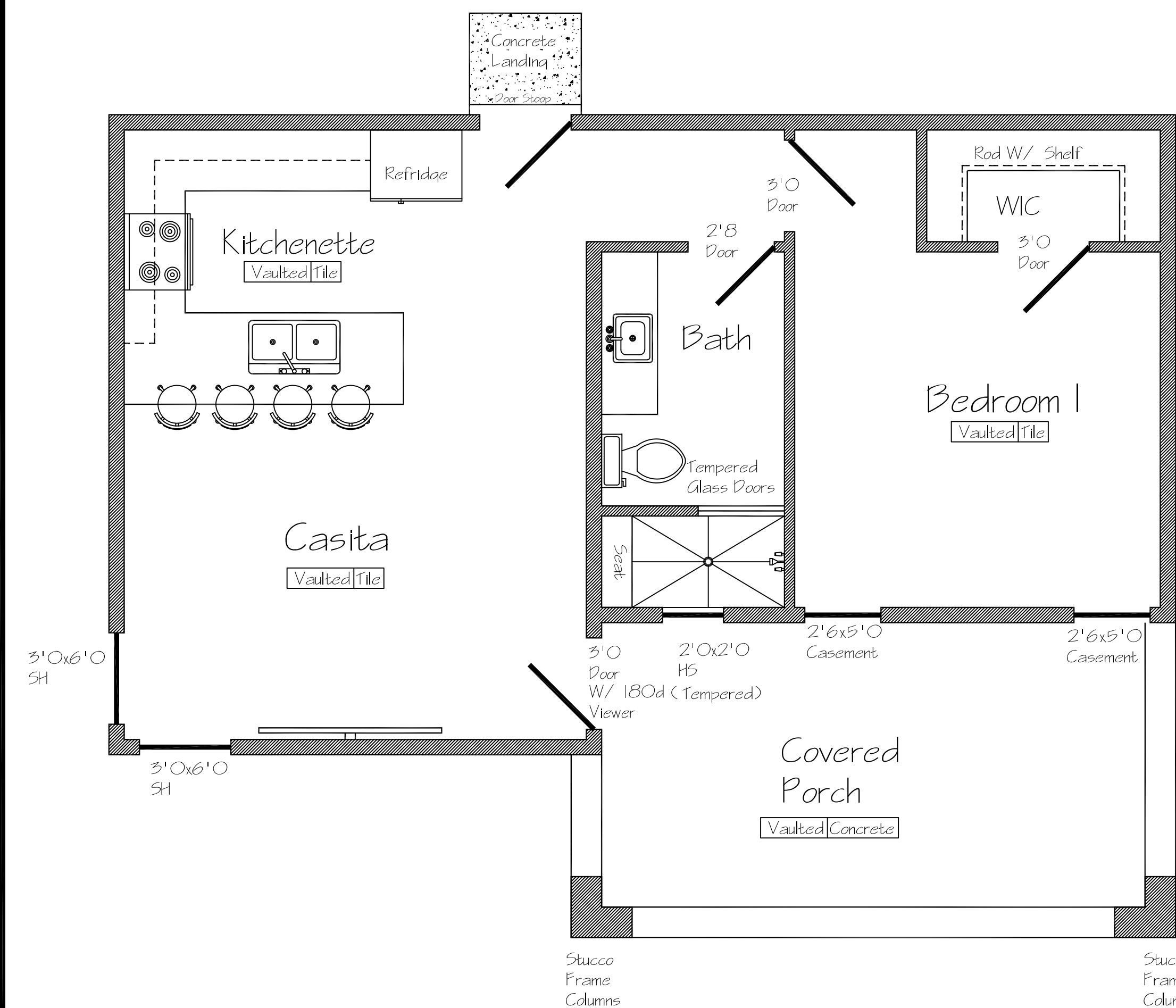

Floor Plan
NTS

2021 NM Residential Building Code

Specifications:

Concrete

2500 PSI For Concrete Slab, Footings, and Retaining Walls Unless Noted.
3.5" Concrete Slab Minimum W/ Optional 6x6 10/10 Welded Wire Mesh. Broom Finish All Exterior Concrete.
2-#4 Re-bar Continuous in Footings and Thickened Slabs Min. 40 Diameters Lap, and Wire Tight. All Stem Walls Fully Grouted.
1/2" x 10" Anchor Bolts A-36 To Post-tension 2 1/2" 2" Embedded 8" At stem Wall.
2" Urethane Insulation at Perimeter of Building and at heated Transition at Garage.

Walls/ Exterior

All Walls To be framed with #2 or Better Grade Lumber SPF, 7/16" OSB at Corners For Shear Strength. All Exterior Sheathing to be solid 7/16" O.S.B. Waterwood. Block all edges of panels. Exterior Walls To be Covered With 2 Layers Grade 17 Building paper or Optional 2 Layers Tyvek House Wrap. 17 Gauge Stucco Meshing W/ 5 Coat Stucco or Optional 20 Gauge Meshing W/ 2 Coat Power Wall or Western 1 Coat Fiberglass Reinforced Stucco System.
All Exterior Windows Double Glass Low-E Units.
All Exterior Doors To Have Threshold and Weather stripping Caulked To Concrete or Subfloor.

Walls Interior

2x4 Studs 16" OC on all Non-loadbearing Walls.
2x4 studs 16" OC at all interior Load bearing walls.
2x6 16" OC at garage thr. separation wall.
1/2" gypsum board at walls and ceiling with texture per Owners Preference. Tape and Bed all Joints. Cement, Fiber-cement and glass mat gypsum backers gypsum backers to be installed in tub and shower behind tile and panels. Green gypsum board not permitted in shower or tub enclosures.
All Interior doors to be 6'8" high unless otherwise noted.

Roof

All Membranes to meet or exceed 900 lbs. 7/16" OSB with H clips at Roof sheathing Stagger all Joints. 6 mil. Poly vapor Barrier Optional w/ R49 Batt Insulation at Ceilings. R-21 At Floor Between 1st Floor unheated and 2nd floor Heated.
All Sloping Flat Roofs to have Min. 1/4" PLF Slope with 3-ply Built-up Roofing.
All Trusses To be Installed per Manufacturers Specifications and all Lateral Bracing per Truss Engineering Locations.
Sloping Roof Trusses Min. 3/12 Pitch.
See attached Engineering for Exact truss Construction and Installation Specs.

Mechanical * Plumbing * Electrical

All Mechanical, Electrical, and Plumbing Contractors To Permit all Work on Project and Install Per UPC, and all applicable Codes and Code Books. When Reviewing Notify Builder Of All Conflicts For Chase Locations and Chase Sizes See Electrical Mechanical Plan For Further Notes.

Heated Area

1st Floor _____ 550 Total Heated 550

SHEET	CITY OF ALBUQUERQUE
2 OF 6	ABQ ADU Model 650 FLAT ROOF

LAST REVISION DATE: 2/14/2024

All Structural steel rebar and re-mesh to be spaced in bottom 1/3 of slab/ footing w/ plastic highchairs

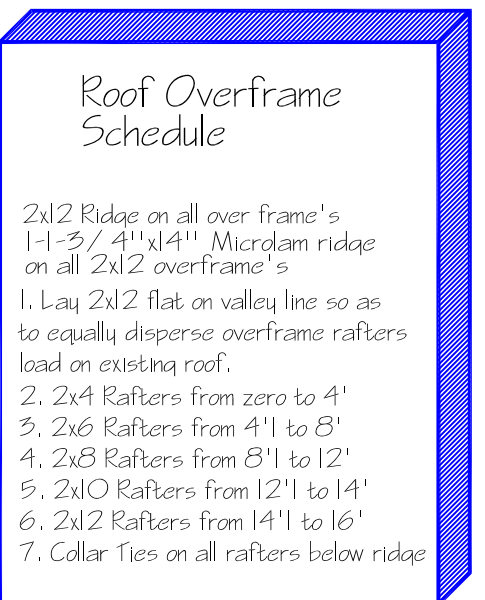
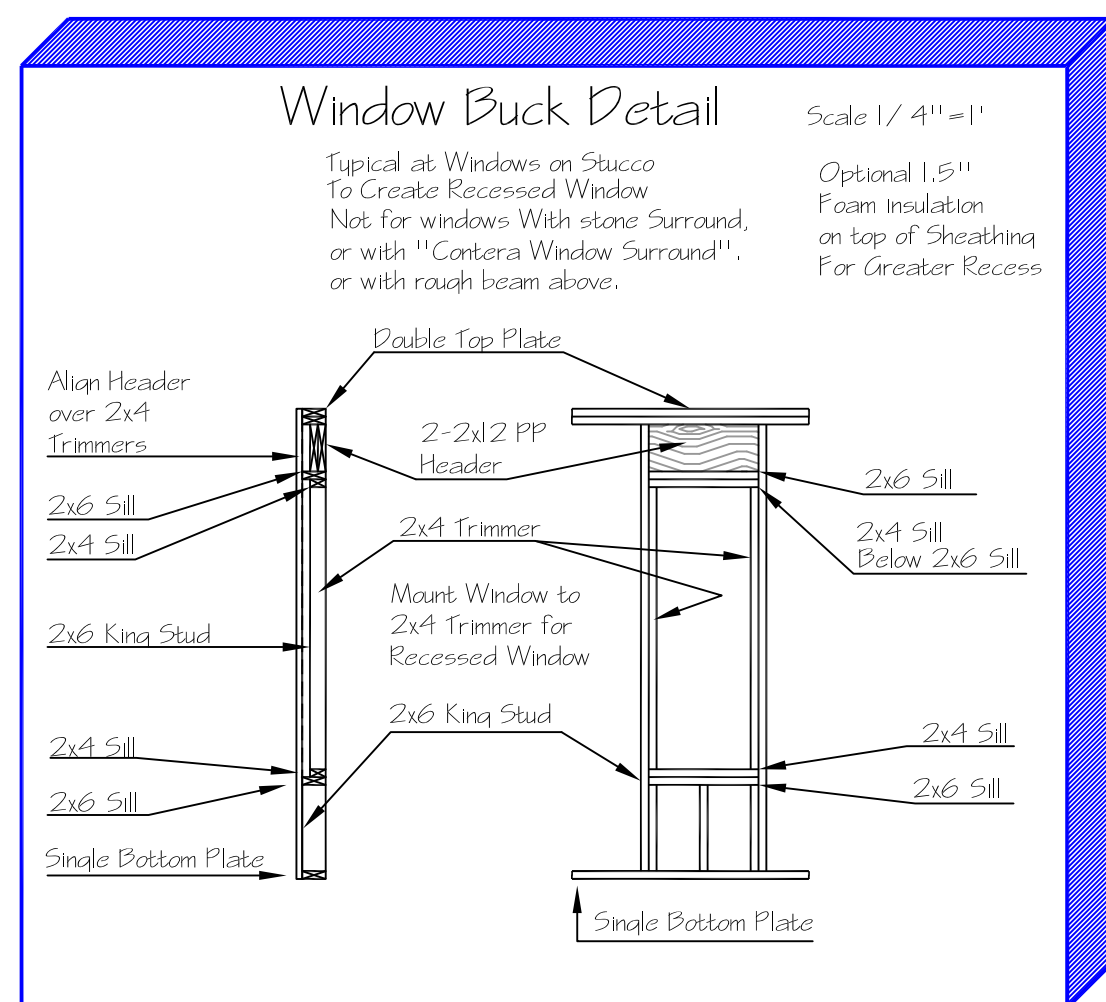
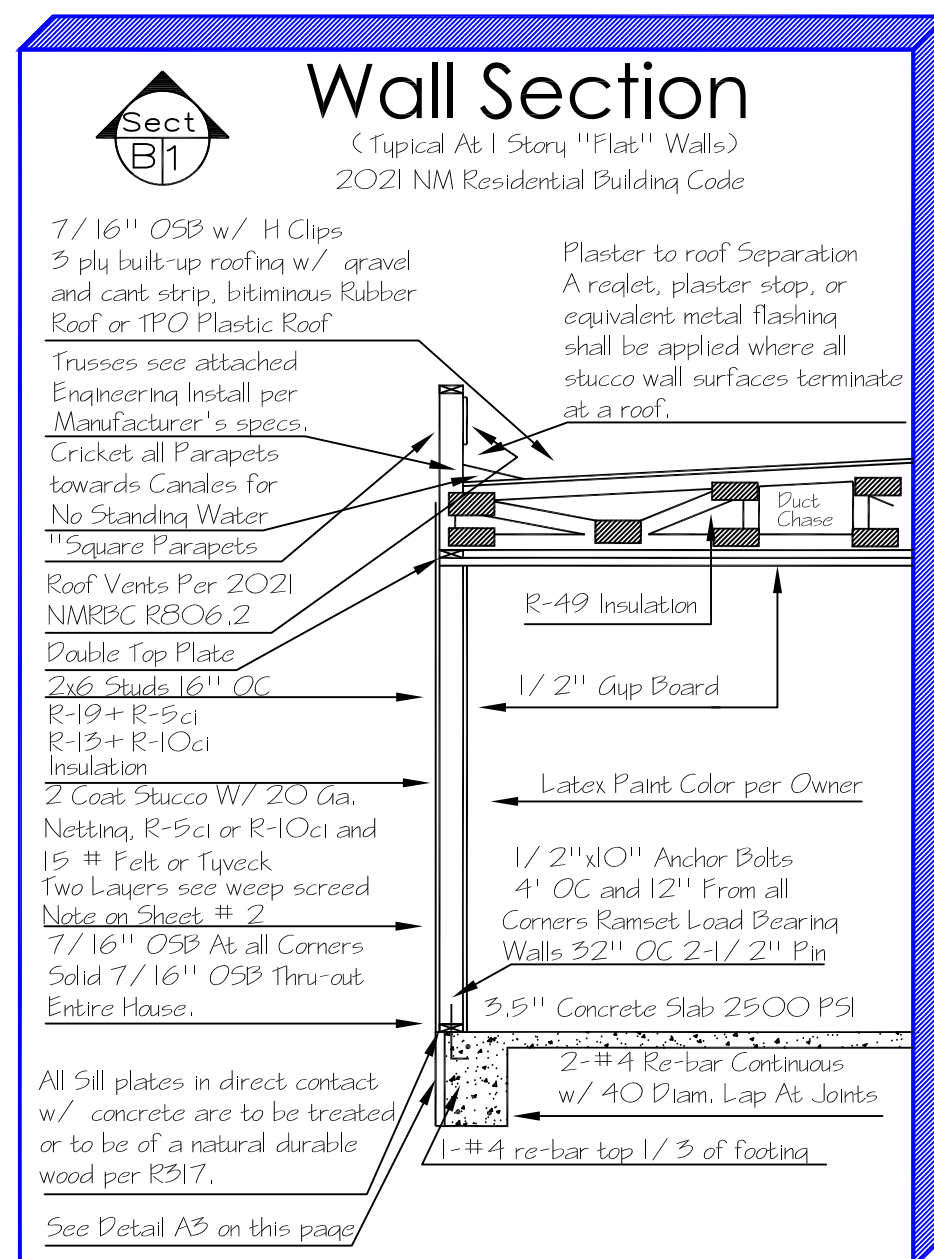
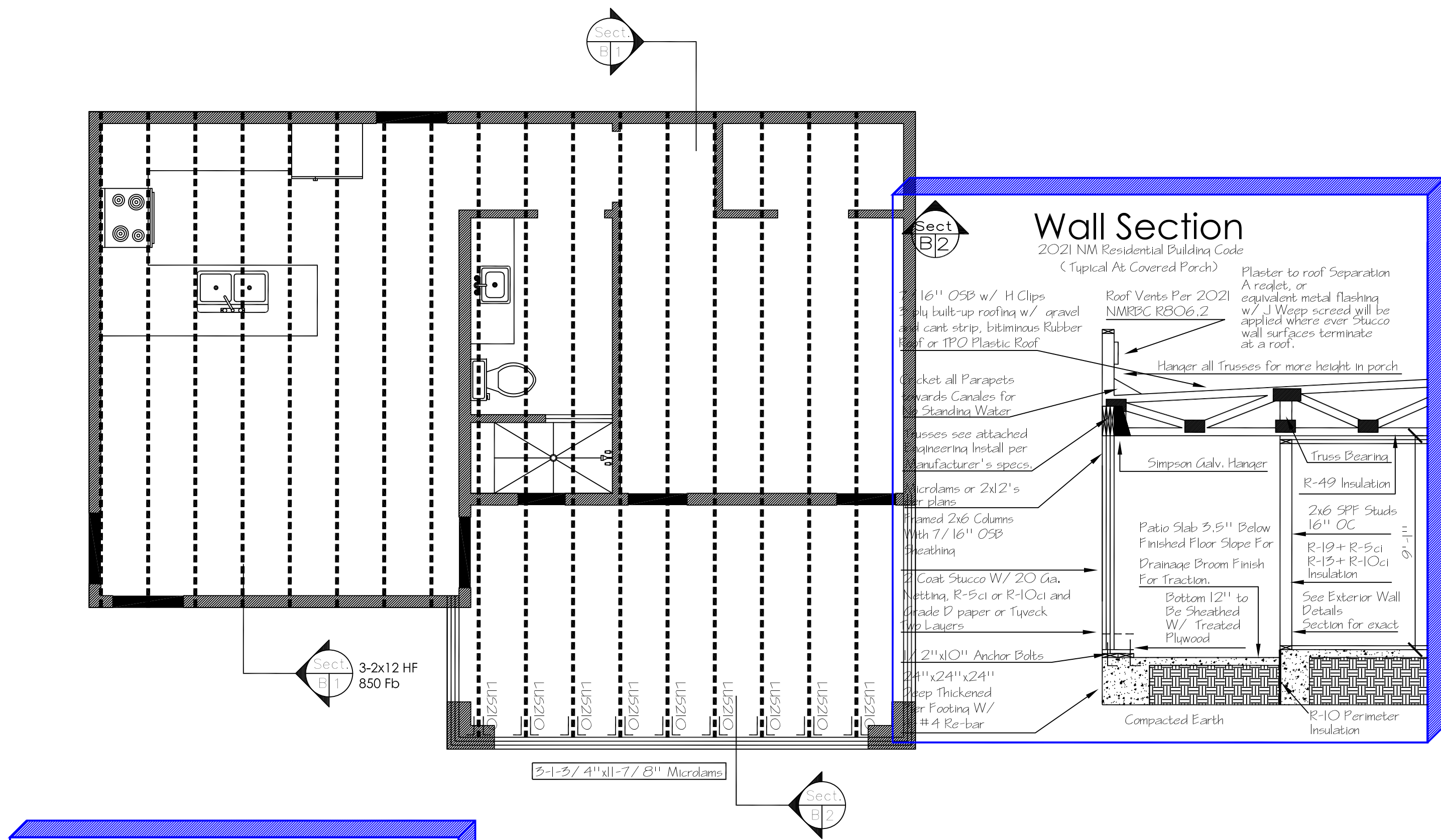

Provide Attic Access Per 2021 NMRBC R507.1

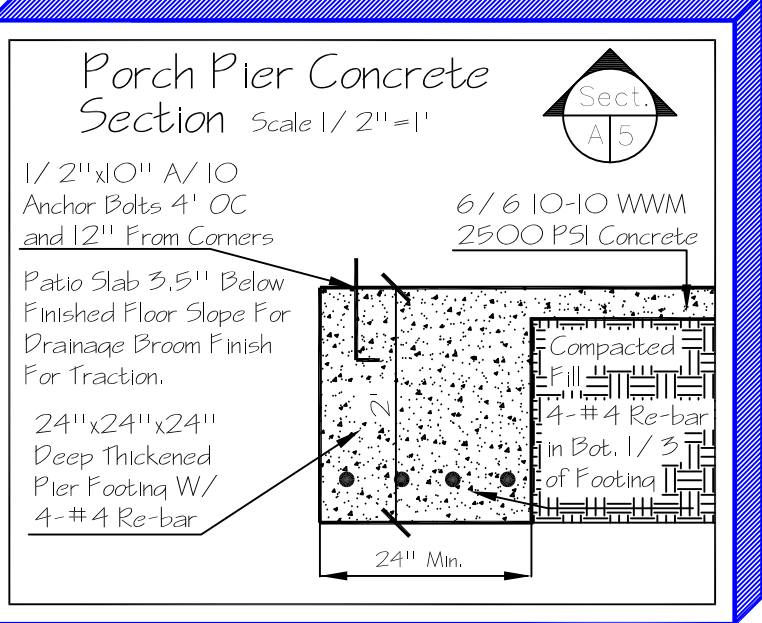
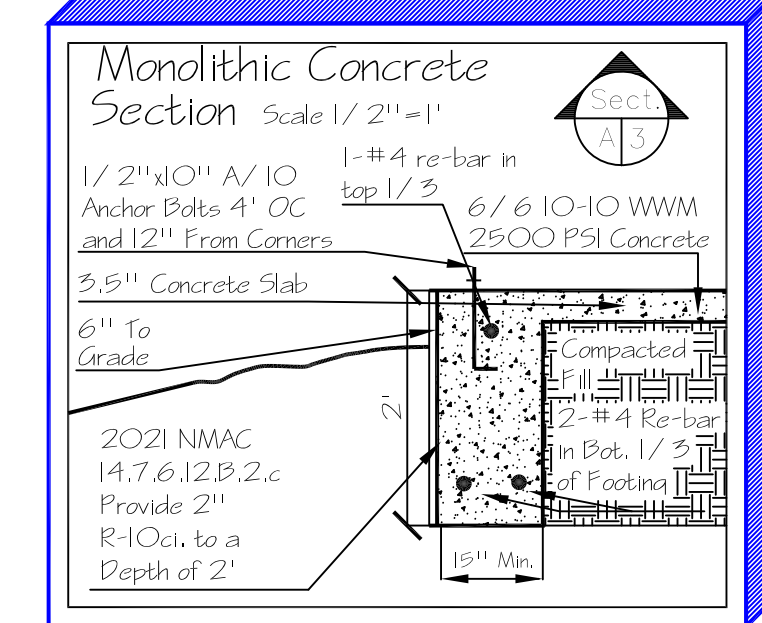
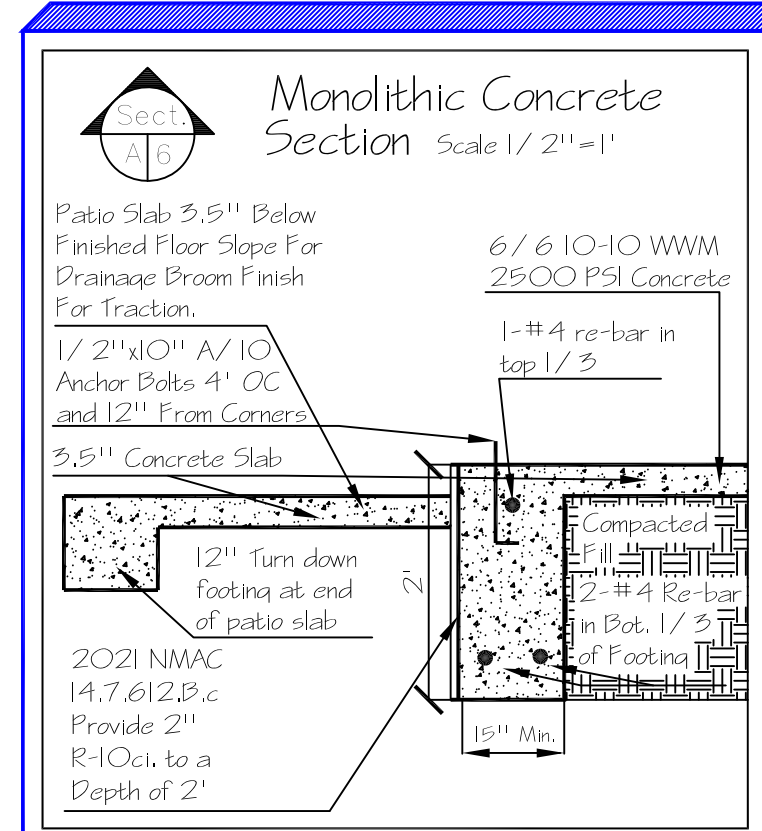
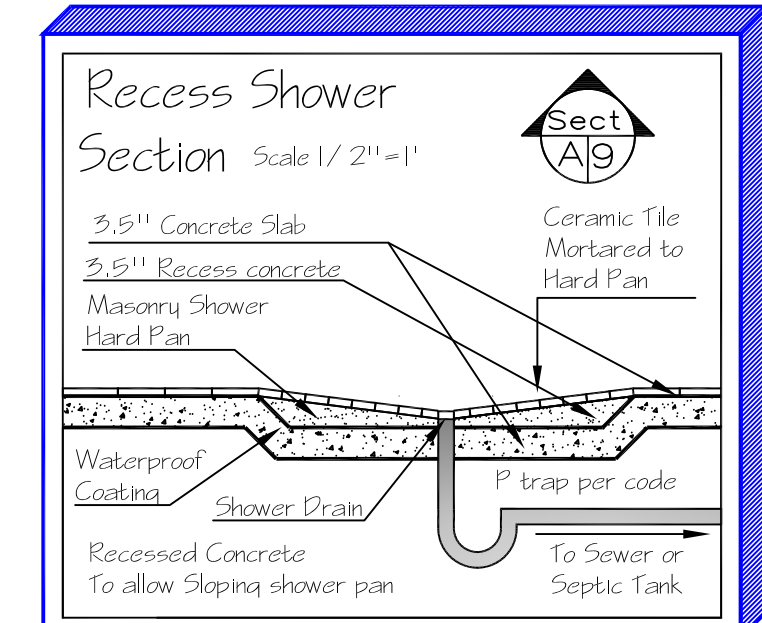
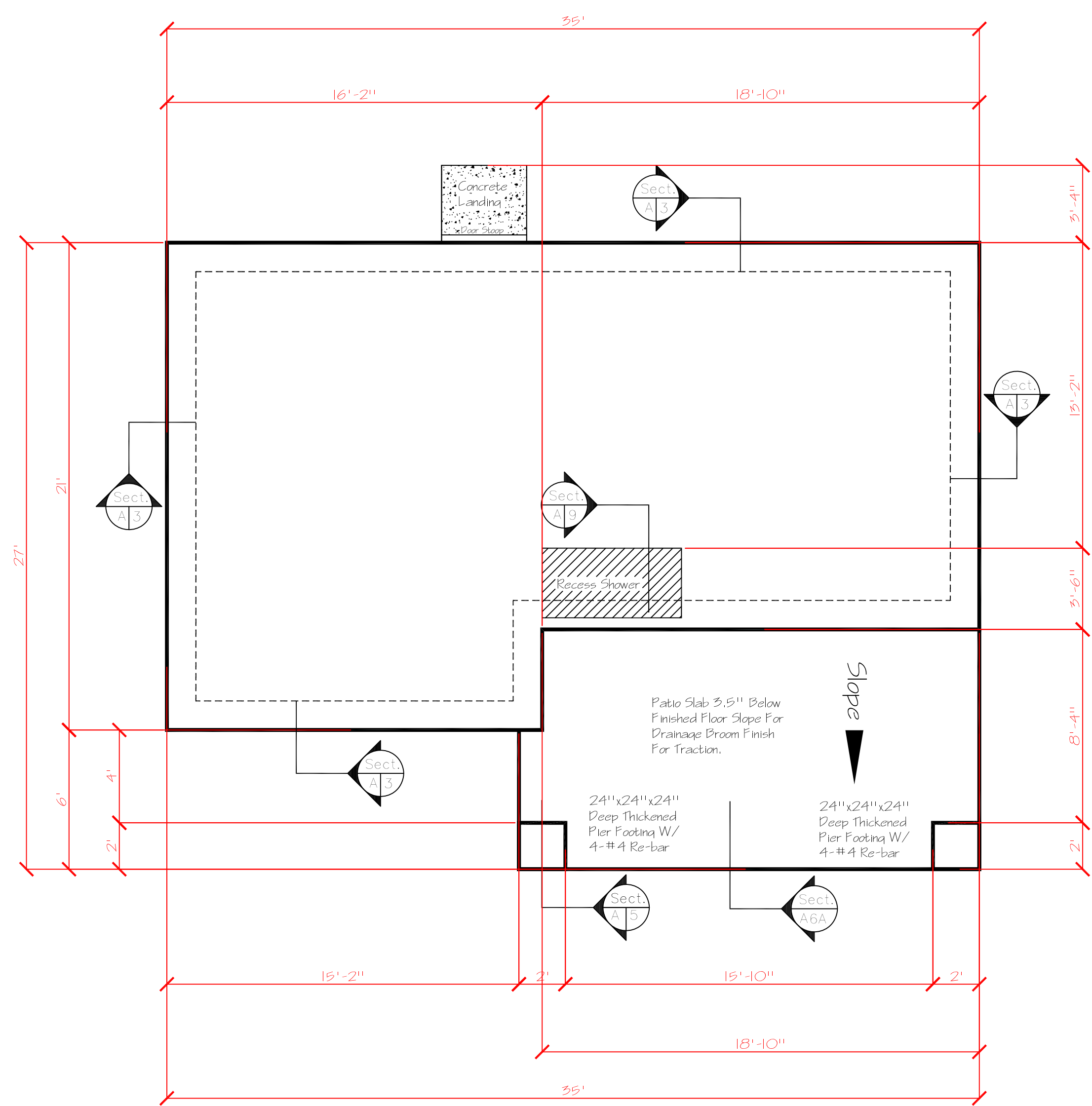

Electrical Panel Note:
At Electrical Panel, Place (2) Full Height Studs on Either side of Blockout, Wall Top plates to be continuous over Box Blockout and support studs. Max. Blockout opening width is 16". Actual R.O. Width is 14.5".

Roof Sheathing Note:
Attach Roof Sheathing w/ 8d Nails @ 6" O.C. on Edges & 12" o.c. Field - Typical unless Noted Otherwise.

Critical Note:
All Trusses to have Uplift Hurricane Strap, To be installed on Exterior Walls and Load Bearing Walls only.

Fire Blocking
Fireblocking: In combustible construction, fireblocking shall be provided to cut off both vertical and horizontal concealed draft openings and to form an effective fire barrier between stories, and between a top story and the roof space. Fireblocking shall be provided in wood-frame construction in the following locations:
1. In concealed spaces of stud walls and partitions, including furred spaces and parallel rows of studs or staggered studs, as follows:
1.1. Vertically at the ceiling and floor levels.
1.2. Horizontally intervals not exceeding 10 feet.

Framing Notes: 2021 NM Residential Building Code	
All Headers at Exterior Walls to be Doubled 2x12 or a Single 4x12 P.F.-975 E-11 Unless Otherwise Noted.	All Micro Lams to be Nailed 12" O.C. With 4-#10 Nails All 4 Member Micro Lams and 4 Member Trusses to be Bolted 16" O.C. with 1/2" x 3" Bolts w/ 1-1/4" Washers.
Minimum 1.5" Bearing at All Headers and Beams to 6" Width. All Headers 6" and Plyer to Have Doubled Trimmers at Both Bearing Points.	All Sill plates in direct contact w/ concrete are to be treated or to be of a natural durable wood per R517.
All Trusses 24" O.C Unless Noted on Plans. All "Flat" Roof's and "Flat Trusses" To have Positive Drainage Min. 1/4" PLF Slope.	All Post's in Direct Contact with Concrete to have Post Base with Min. 1" Air Gap or 1-1/2" Treated Plate Ramset to Concrete with Post Nailed on Top.
All Interior Load Bearing Walls to be Spaced 16" O.C. to 10'1"	All Splices in Bottom Plates at All Load Bearing Walls to be Shot w/ 2-1/2" Ramset Powder Actuated Pins. Also 12" From All Corners Unless an Anchor Bolt is Present. Ramset all Interior Load Bearing Walls 52" O.C. With 2-1/2" Pins w/ Washers.
Solid Bearing Points under all Beams, if Beam is on Second Floor Continue Bearing Between Trusses and First Floor to Solid Concrete Footing.	

Typical at All Exterior Footings 18" Depth below grade, 6" Above Grade, 24" Total footing from top of slab to bottom of footing.

Note:
An Electrode Encased By at Least 2" of Concrete, Located Within and Near The Bottom of a Concrete Foundation or Footing That is in Direct Contact with the Earth, Consists of at Least 20' of one or more electrically conductive Steel Reinforcing Re-bar of Not less than 1/2" Diam.

2021 NMRBC R311.3 Landings at Doors Leading to outside. Note: Min. 3' Landing Outside Of all Doors Leading Outside Of Building. See Concrete Plan For Exact Locations.

Concrete
NTS

Concrete Notes
2021 NM Residential Building Code

- Concrete Strength: 2500 PSI Min. 3 1/2" Minimum Thick Slab on Compacted Fill.
- All Footings Min. 15" Wide, 22" Thick with a Excavation Depth of 18" West of Sandia Mountains, 21" East Of Mountains at All Exterior Walls.
- All CMU Walls For Foundation To Be 8" x 8" x 16" Min. With Joint Reinforcement 16" O.C Vertical, 48" O.C Max.
- Anchoring: Min. 1/2" x 10" Anchor Bolts @ 4' O.C Max. and Within 12" From End Of Plate. Powder Actuated Fasteners @ 24" O.C Max. and Within 12" From End Of Plate For Interior Bearing Sole Plates Not Permitted For CMU Stem Walls.
- Re-bar: 2-#4 Re-bar Continuous at All Footings with Min. 40 Diam. Lap At Joints, Reinforcement Steel Secured in Place, Min. 3" Coverage.
- Interior Load Bearing Footings: 12" Min Width x 12" Min. Depth at All Interior Footings.
- All Adobe Wall Footings To Be 2" Wider Than Wall, 4" Above Floor Stabilized Bond Beam Min. 6" x 10" With 2# 4 Re-bar. (Radiant Heated Slabs R15).
- Foundation Insulation: 2" x 24" R-10ci At Exterior Perimeter Of Heated Space and at Garage/ House Wall. Wood Floors Require a Minimum Of R-21 Insulation. Insulation Shall Extend From Top Of Slab 24" Down, or continue Horizontally Under Slab For a Total Of 24".
- Under Floor Clearance: 18" To the Bottom Of Wood Joists and 12" To The Bottom of Wood Girders. Provide a Min. Under Floor Access of 18" x 24".
- Provide cross Ventilation of Minimum 1 Sq. Ft. Per 150 Sq. Ft. of Under Floor Area Excavations and Foundations: To Conform to Chapter 13 and 9.5. Ascending and Descending Slopes, Cuts, Gut/ fills. All Footings Must Extend a Minimum of 12" into Undisturbed Soil or a Soil Investigation Report and a Report of Satisfactory Placement Of Fill Shall Be Provided To Permit Office For Review and Approval.

Frame Plan
NTS

SHEET 3 OF 6
CITY OF ALBUQUERQUE
ABQ ADU Model 650
FLAT ROOF

LAST REVISION DATE: 2/14/2024

Lighting Legend 2021 NMRBC	
	Mini Recess Light Caulk and seal to ceiling Energy Star Rated, Energy Star Bulb
	Bulb-type Recess Caulk and seal to ceiling Energy Star Rated, Energy Star Bulb
	Full Recess Light Caulk and seal to ceiling Energy Star Rated, Energy Star Bulb
	Wall Sconce or Light Bar Energy Star Rated, Energy Star Bulb
	Track Light Caulk and seal to ceiling Energy Star Bulb
	Exhaust Fan Energy Star Rated, to have Occupancy Sensor or automatic-timer switch 20 cfm cont.
	Ceiling Fan w/ Reverse Switch separate light switch, Energy Star rated w/ energy star Rated Bulbs.
	Pendant Lighting Energy star Rated w/ energy star bulbs
	Motion Light w/ Motion Sensor and Photo light cell Detector

Note:
An Electrode Encased By at Least 2" of Concrete, Located Within and Near the Bottom of a Concrete Foundation or Footing That is in Direct Contact with the Earth, Consisting of at Least 20' of one or more electrically conductive Steel Reinforcing Re-bar of Not less than 1/2" Diam.

Electrical Notes:

All Outlets Shall Be 12" From Finish Floor unless Otherwise Noted.
All Outlets in Kitchen, Utility Room, and Garage to Be 44" above Floor and To Be Ground Fault Interrupt Protected.
Copper Wire To Be Used Throughout House and all Exterior light fixtures, outlets, and switches to be Weatherproof, and Ground Fault Interrupt Protected.
All Bathroom Outlets To Be Ground Fault Interrupt device Equipped.
Swamp Coolers To have High-Low Switch Settings and To be Located per Owner, Mech. Contractor Locations.
All Smoke Detectors To Have Battery Back-up and To be Hardwired Together in a loop with an Audible Alarm. Smoke Det. to have Carbon Monoxide Warning as well.

IF Required Whirlpool Switch to be located not less than 5' from tub or to have an air activated Switch.
All Ceiling Fans to have variable speed control.
Plumbing Notes:
1" Lead-in pipe from well or public water supply. Minimum 100' from well to septic system.
Hose Bib to be Located at front, Back, sides per Owners Locations.
All Plumbing to be permitted and Executed as per Uniform Plumbing Code. Ice Maker Rough-in to be located behind Refrigerator.
Electrical to be Grounded to Copper water Lines as Well as with a grounding rod. See Attached note For Grounding specs to Foundation Re-bar.

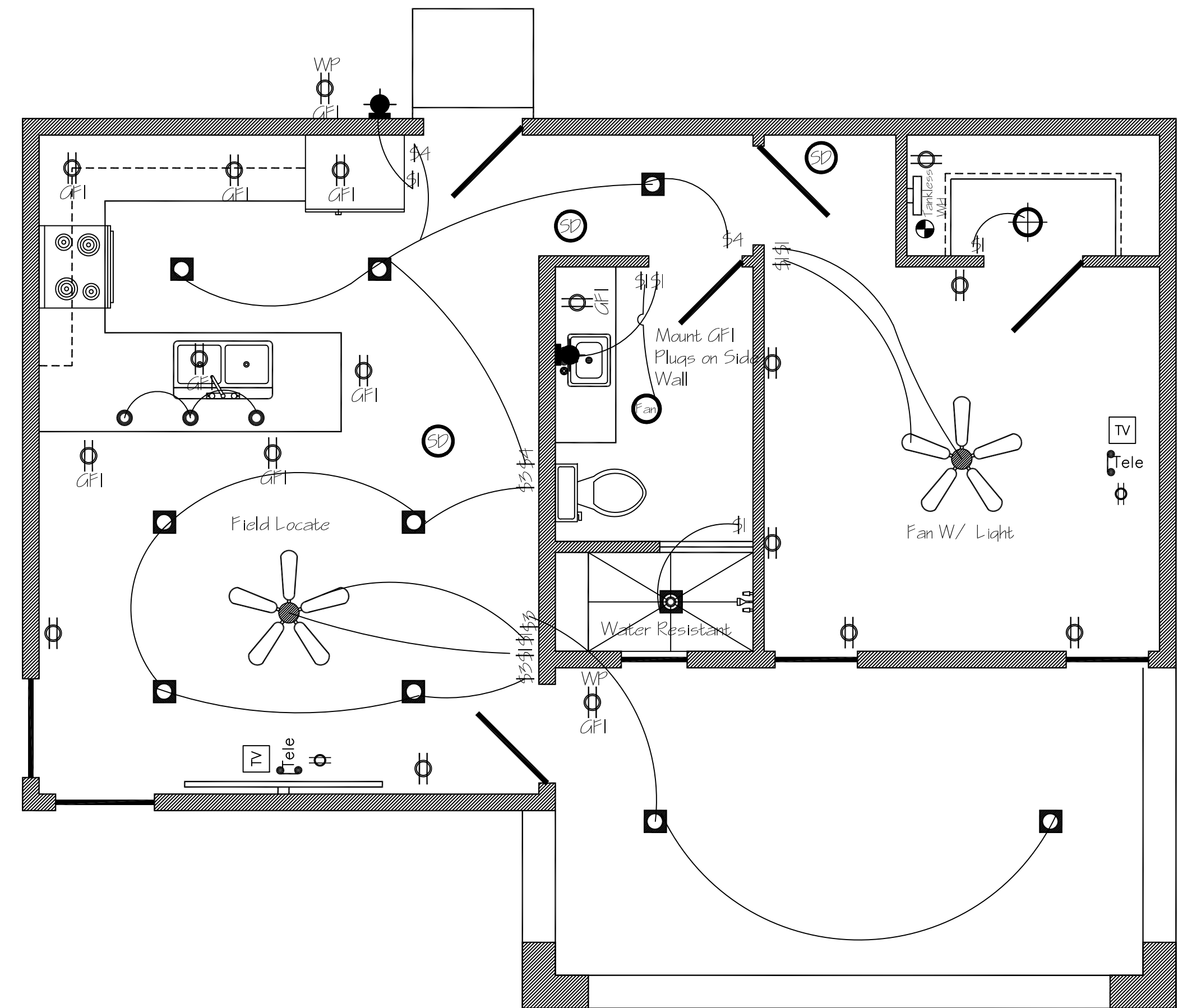

Plug Switch Legend NM 2015 IRC	
	Wall Plug
	Ground Fault Interrupt Counter Plug
	Waterproof Ground Fault Interrupt Exterior Plug
	220 Volt 30 amp plug
	Natural Gas or Propane
	Telephone Connection plug
	Cable TV or Satellite Outlet
	Programmable Thermostat one for Each Heating Unit
	One Way Operated Switch
	Two Way Operated Switch
	Three Way Operated Switch
	Timer Operated Switch
	Motion Sensor Switch
	Floor Plug
	SD/CO Detector

Note:
Provide WP/ GFI Protected Receptacle within 25' of Exterior Mechanical Equipment

Note:
Arc-Fault Circuit-Interrupter Protection Shall Be Provided in All Rooms, 15 and 20 Amp Receptacles and all Branch Circuits to be Protected by Arc-Fault Circuit Interrupter's, All Receptacles to be Tamper resistant.

All electrical work must be accordance with the 2020 NM Electrical Code

Electrical

NTS

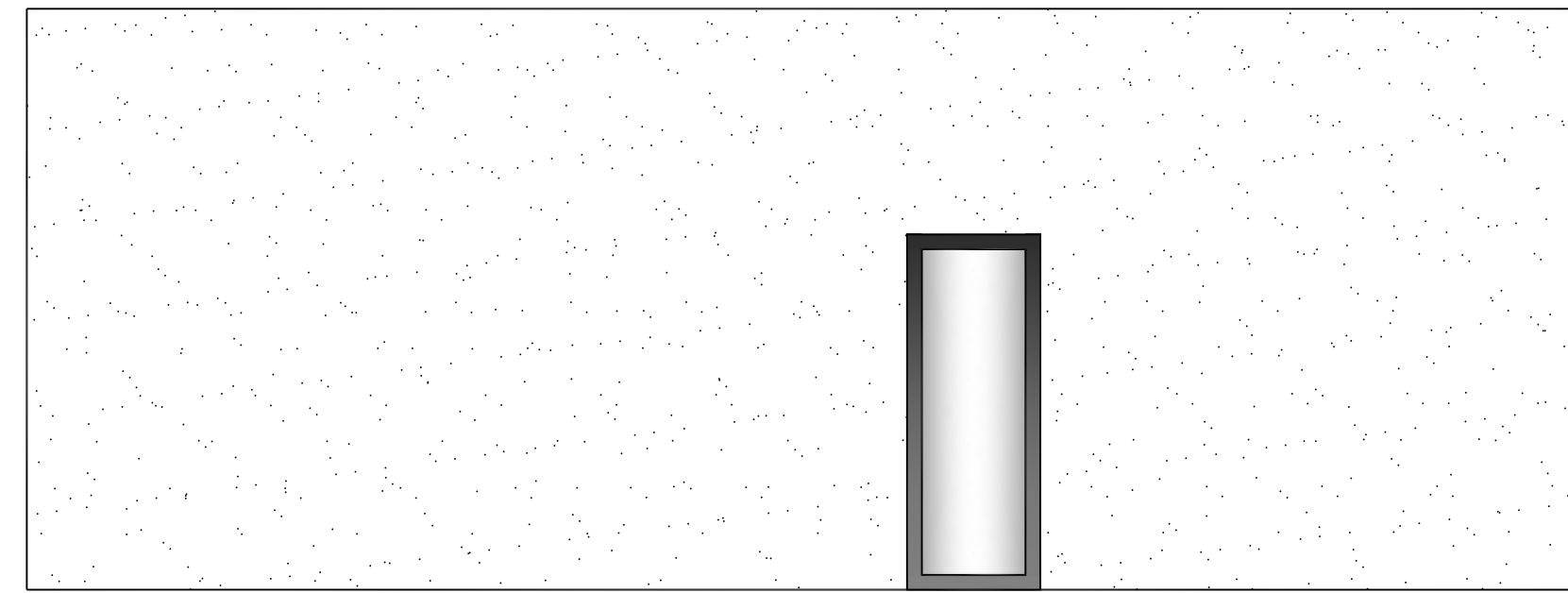

Back Elevation

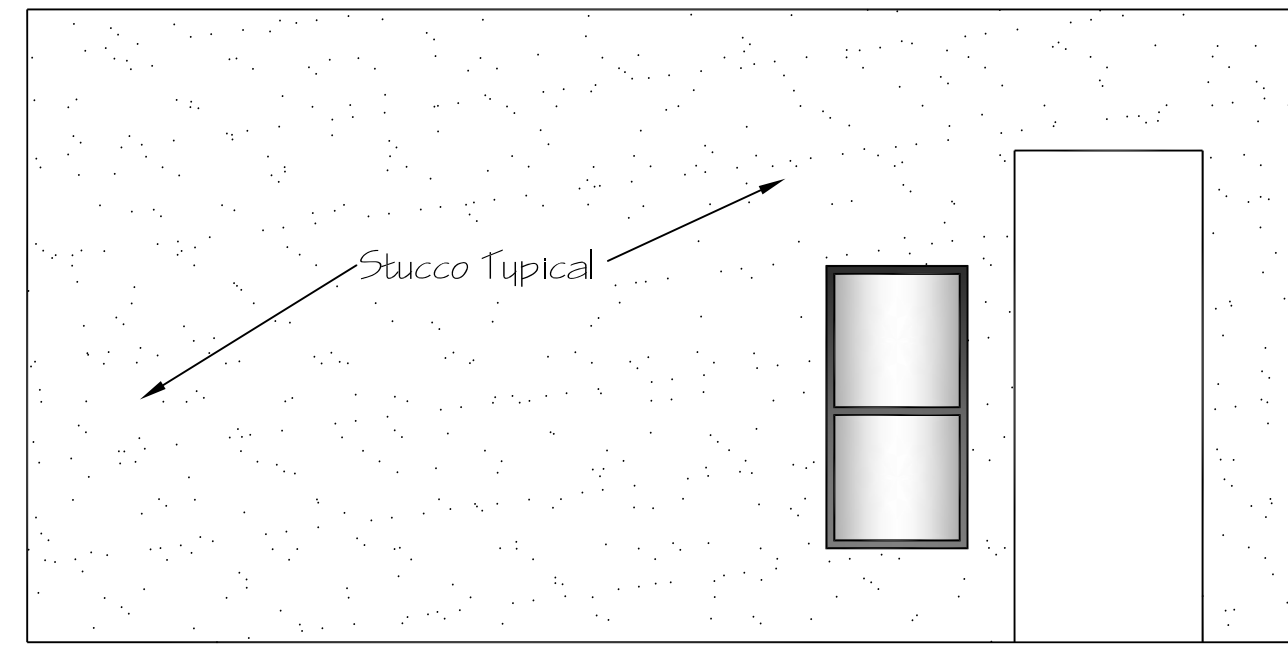

Left Elevation

Provide 2" Recessed Windows

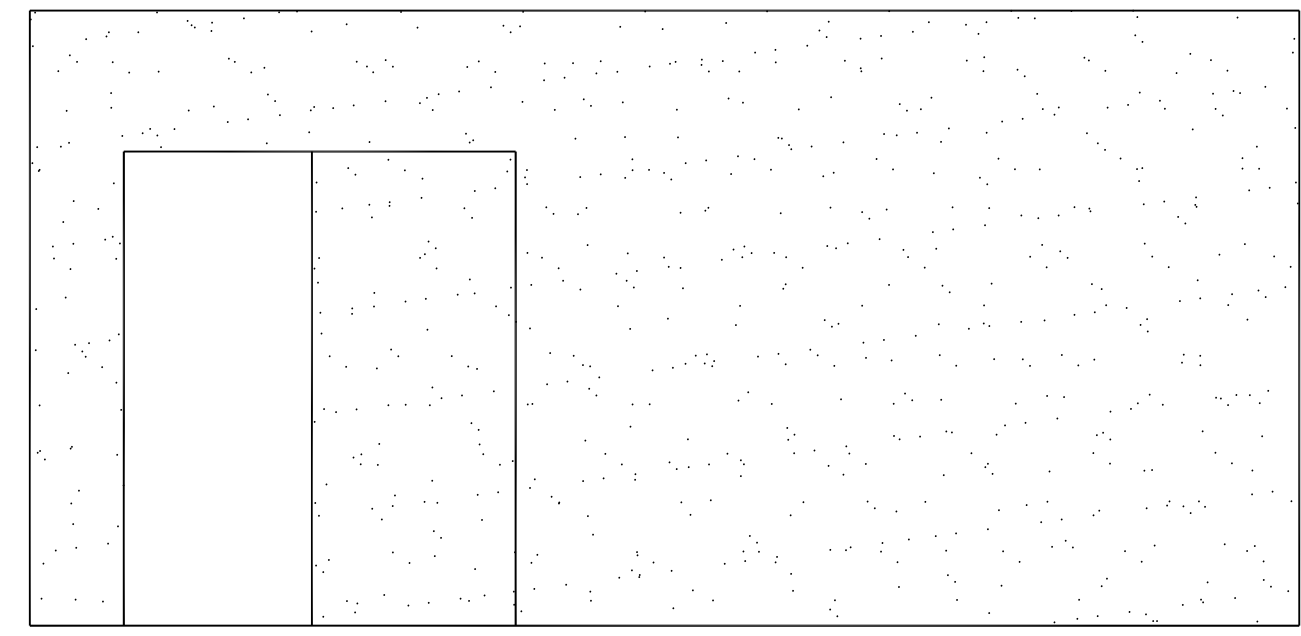

Right Elevation

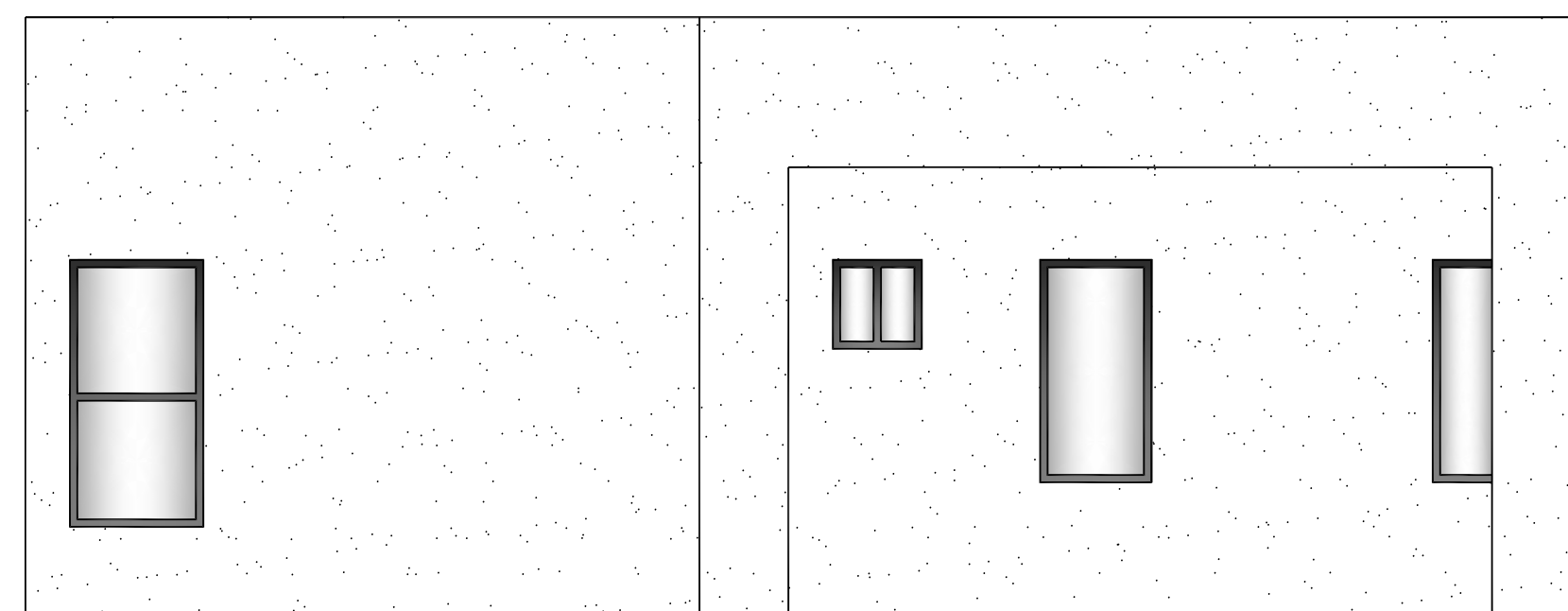

Front Elevation

Provide 2" Recessed Windows

Elevations

NTS

SHEET	CITY OF ALBUQUERQUE
4 OF 6	ABQ ADU Model 650 FLAT ROOF

LAST REVISION DATE: 2/14/2024

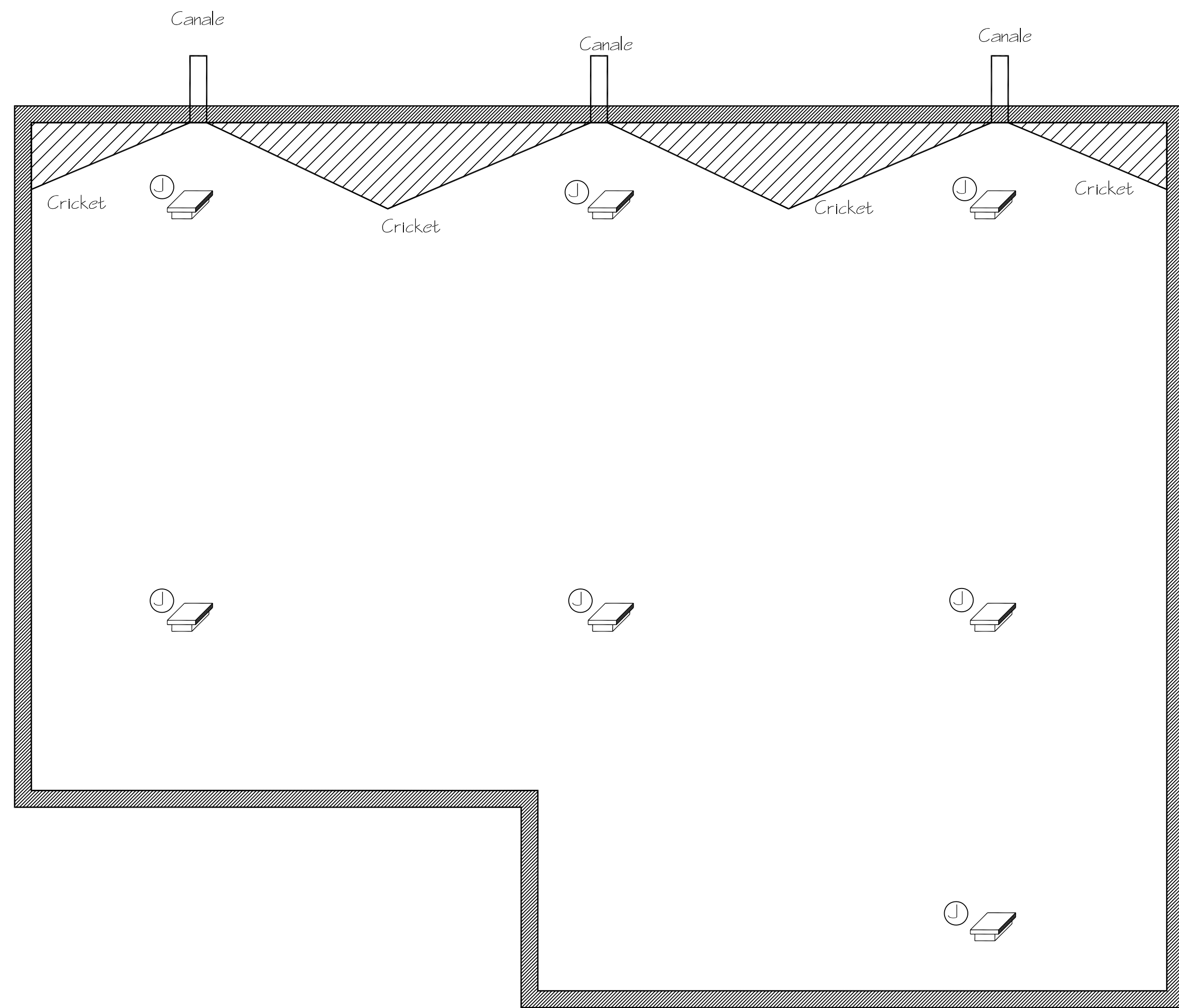

Mass # 1			
Vent	Quantity	Net Free Area	Total Square Inches
⓪	4	144	576
Grand Total		576 / 144 = 4.0	

Venting Required/ Provided				
Mass # 1	Total Area	Pitched or Flat	Venting Required	Venting Provided
	600	600/150 = 4.0	4.0	4.0

Ventilation

NTS

Attic Venting Chart			
Key	Vent Type	Brand	Net Free Area
⓪	8" x 16" Soffit Vent	Lomanco	65 Square Inches
⓪	Soffit vent strip	Familip	12 Square Inches per foot
⓪	18" x 24" Gable vent	Lomanco	180 Square Inches
⓪	18" Round Gable vent	Mel America Inc.	26 Square Inches
⓪	22" Round Gable vent	Mel America Inc.	64 Square Inches
⓪	14" x 22" Architect Gable vent	Mel America Inc.	90 Square Inches
⓪	8" x 16" Stucco Vent	CMJ Inc.	81 Square Inches
⓪	14" x 18" Gable vent	Lomanco	56 Square Inches
⓪	12" x 12" Gable Vent	Lomanco	106 Square Inches
⓪	155 - 20" x 25" x 7.75"	Lomanco	144 Square Inches
⓪	VN 5050 21" x 21" W/ Bird Screen	C.J. Metal Products	420 Square Inches
⓪	Tile Ridge Vent TRV-4	Lomanco	18 Square Inches Per Linear Ft.
⓪	Soffit vent strip	Familip	12 Square Inches per foot
⓪	O'Hagan	O'Hagan's Inc.	72 Square Inches
⓪	Shingle and Metal Ridge Lo-Omnifall	Lomanco	11 Square Inches Per Linear Ft.
⓪	TV-9 Tile Vent	Lomanco	56 Square Inches
⓪	DA-4 Edge Vent	Lomanco	56 Square Inches
⓪	HCO Continuous Soffit Vent	Lomanco	88 Square Inches

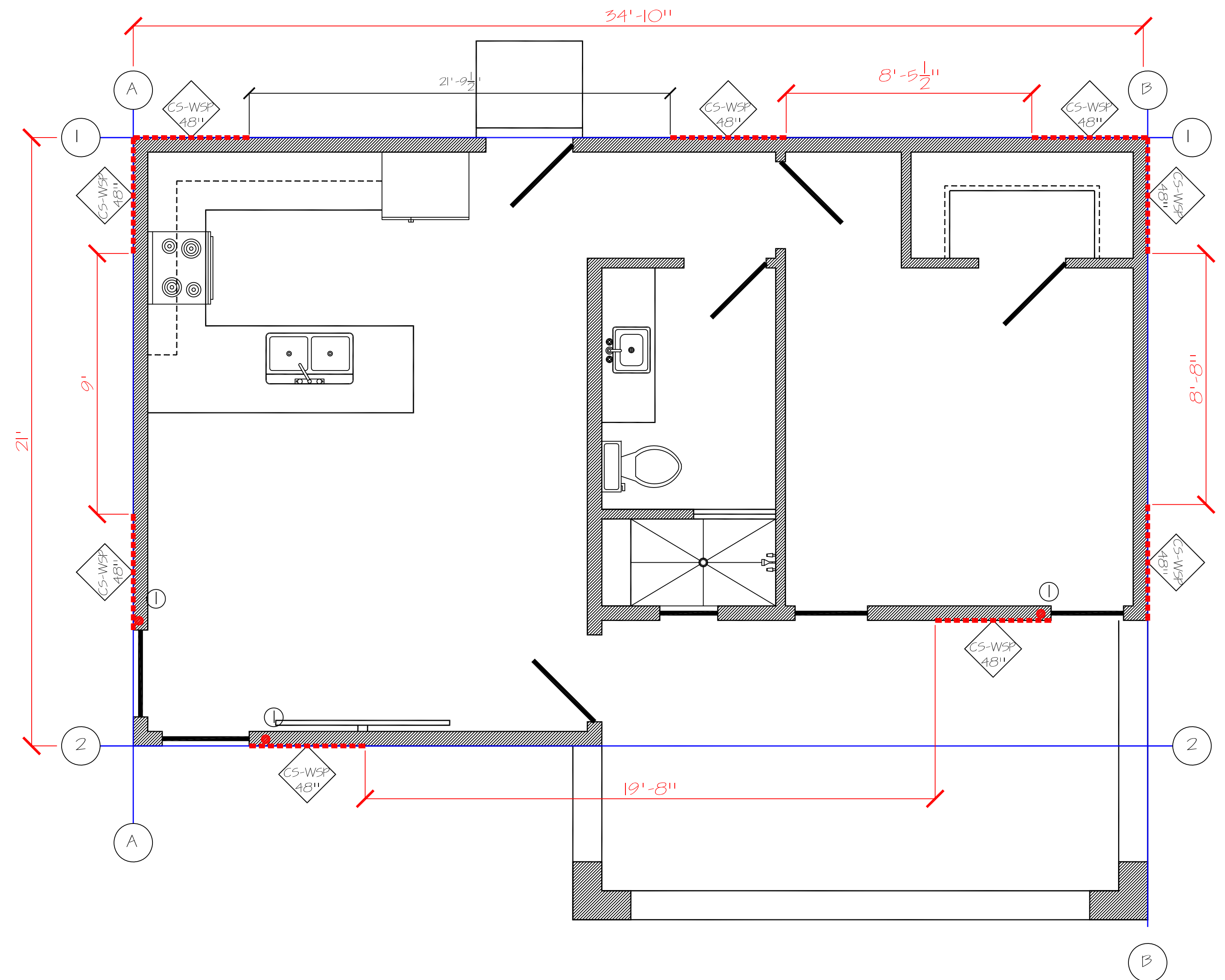

Hold downs Schedule		
⓪	D112Z	1825 lb

Wall Brace

NTS

SHEET	CITY OF ALBUQUERQUE
5 OF 6	ABQ ADU Model 650 FLAT ROOF

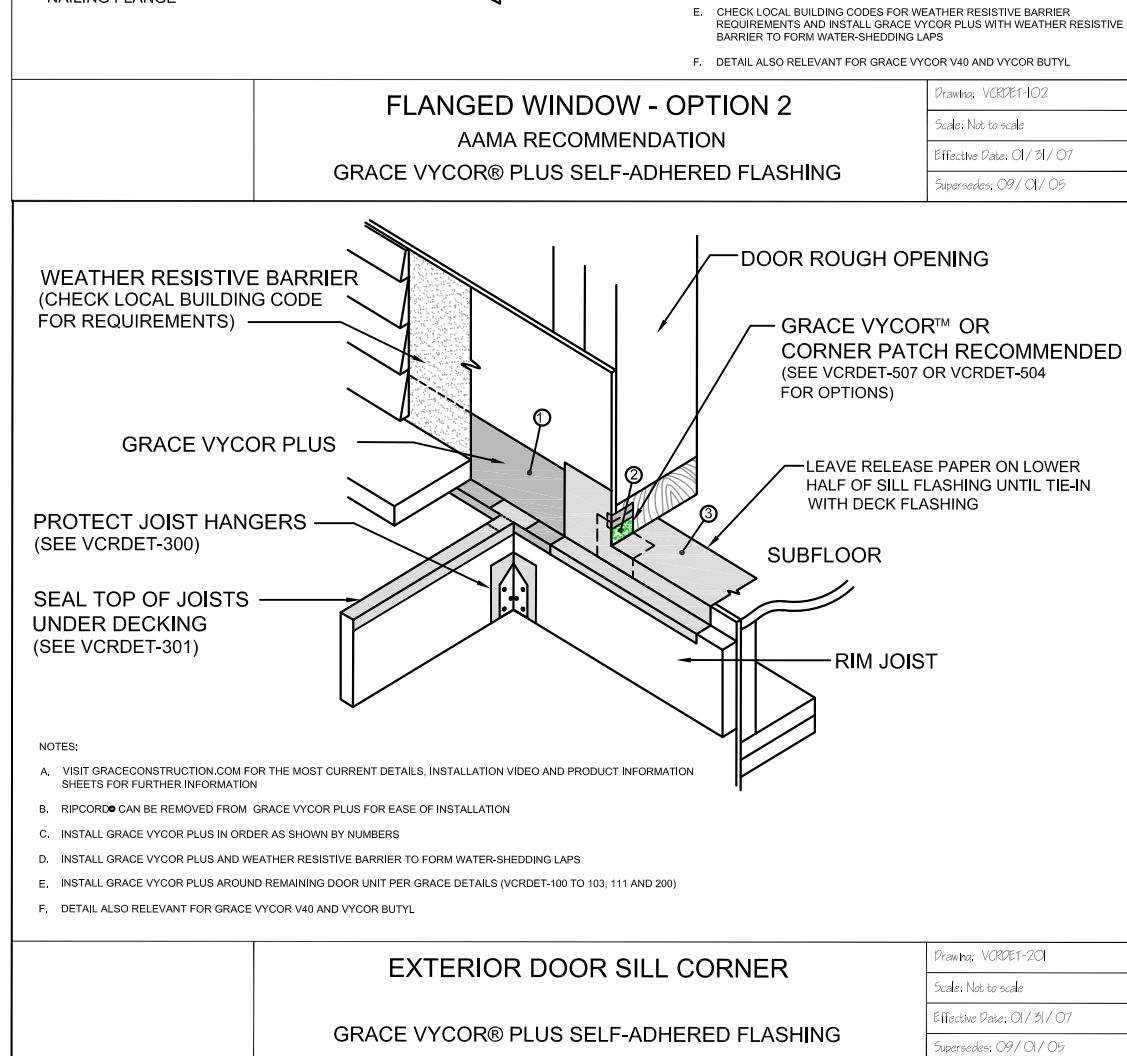
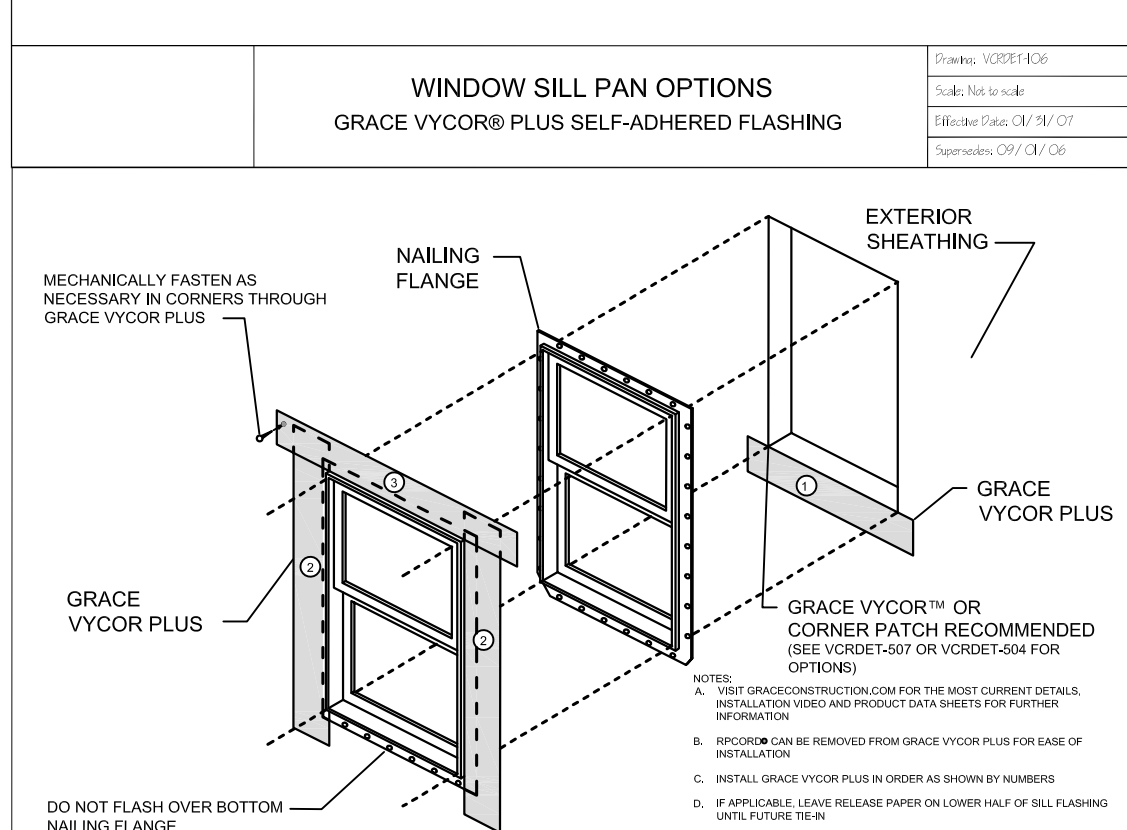
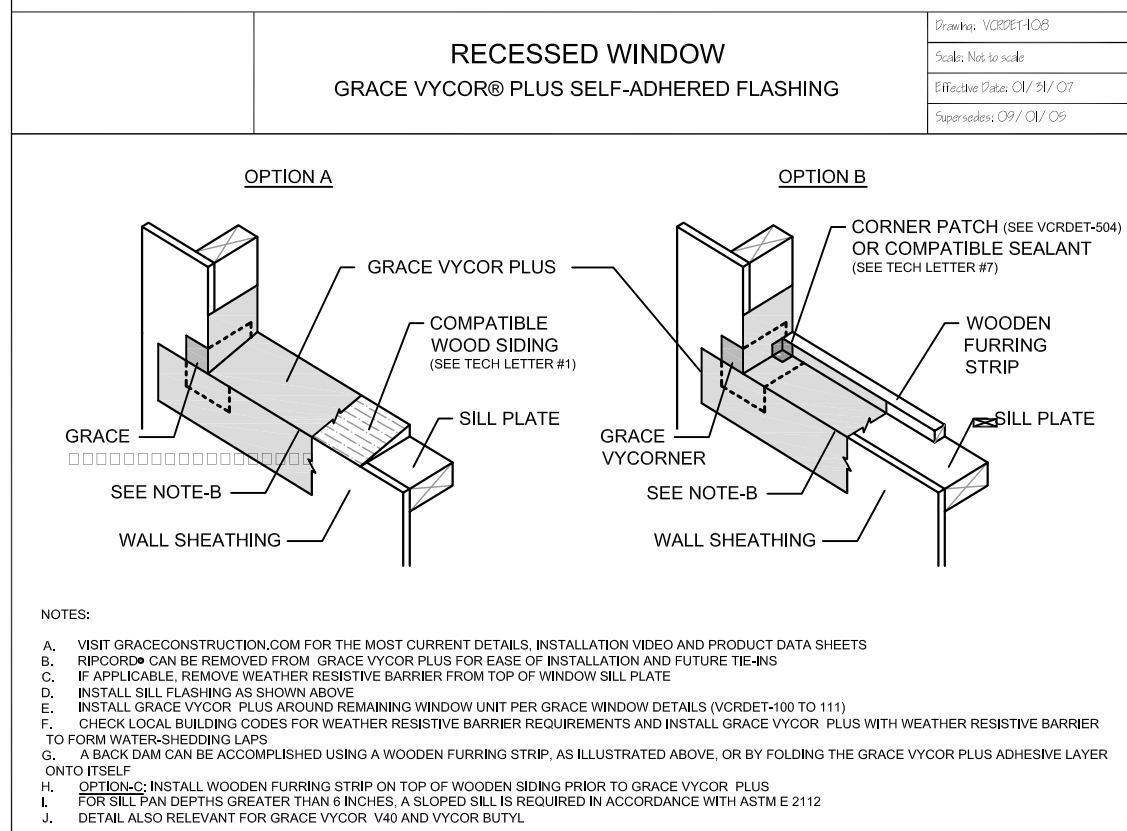
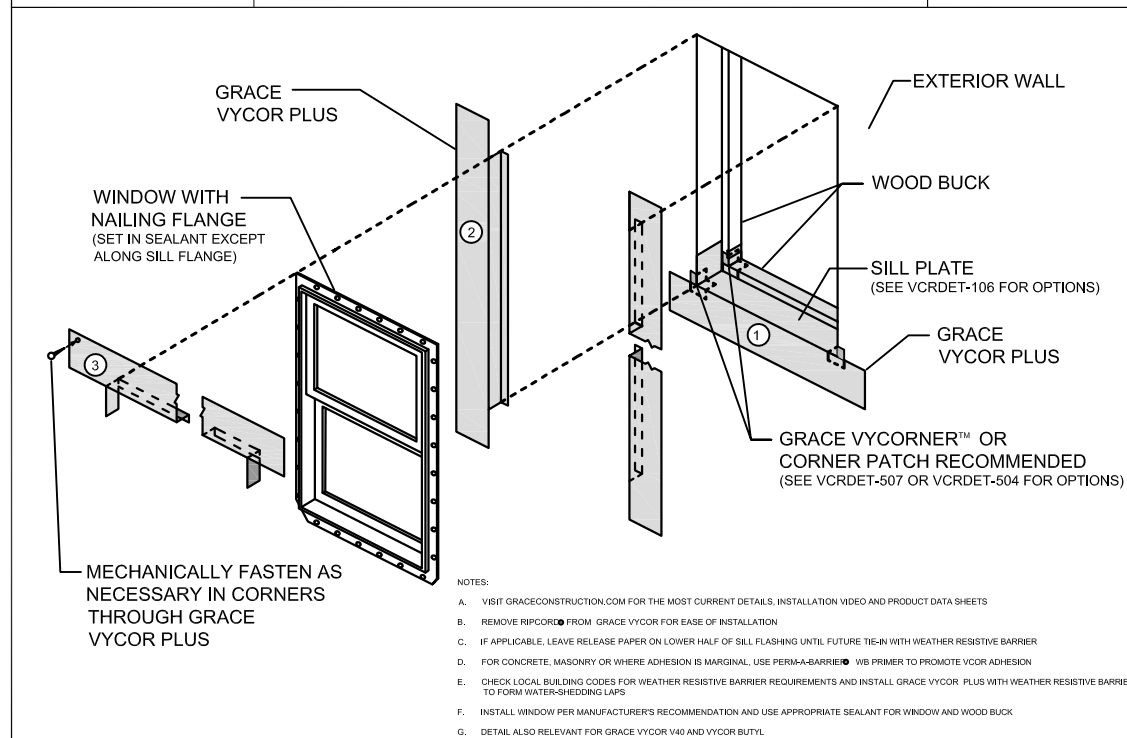
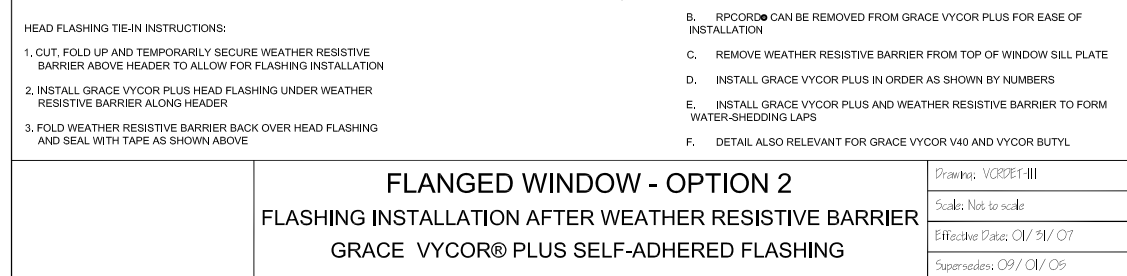
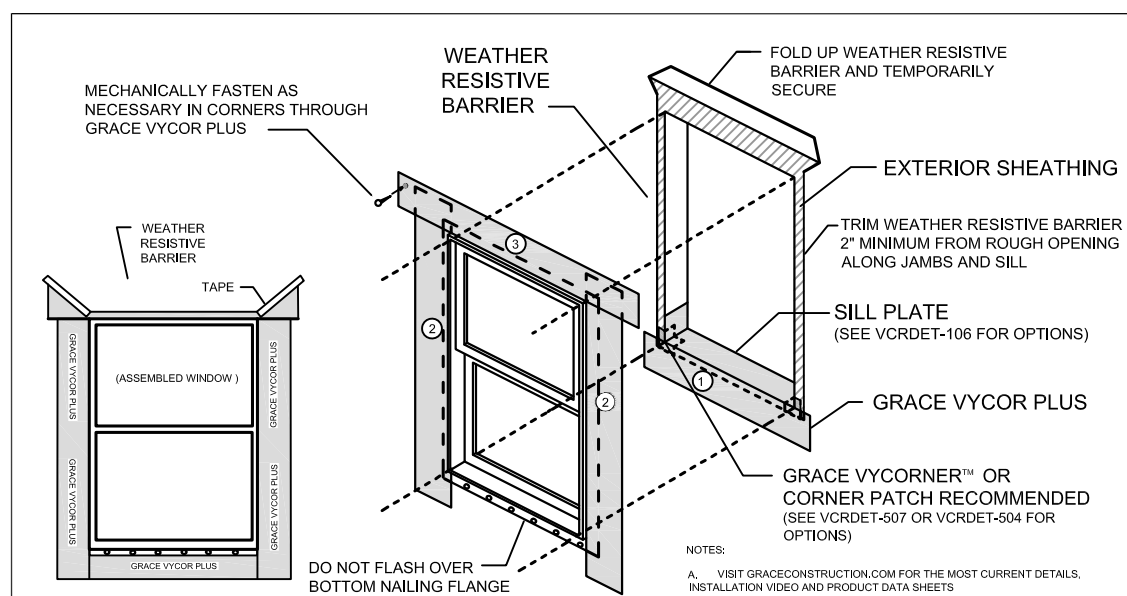

Air Leakage

Building Thermal Envelope.
The Building thermal envelope shall be durably sealed to limit infiltration. The sealing methods between dissimilar materials shall allow for differential expansion and contraction. The Following shall be caulked, gasketed, weather stripped or otherwise sealed with an air barrier material, suitable film or solid material.

Solar Reflectivity:
All Flat Roof Area's to be coated with "Solar Mastic"™ Ultra premium cool roof coating or Equivalent in White or Desert Tan, per energy code.

Critical Note:
All Windows, doors and skylights to be caulked, gasketed, weatherstripped or otherwise sealed with an air barrier material, suitable film or solid material.

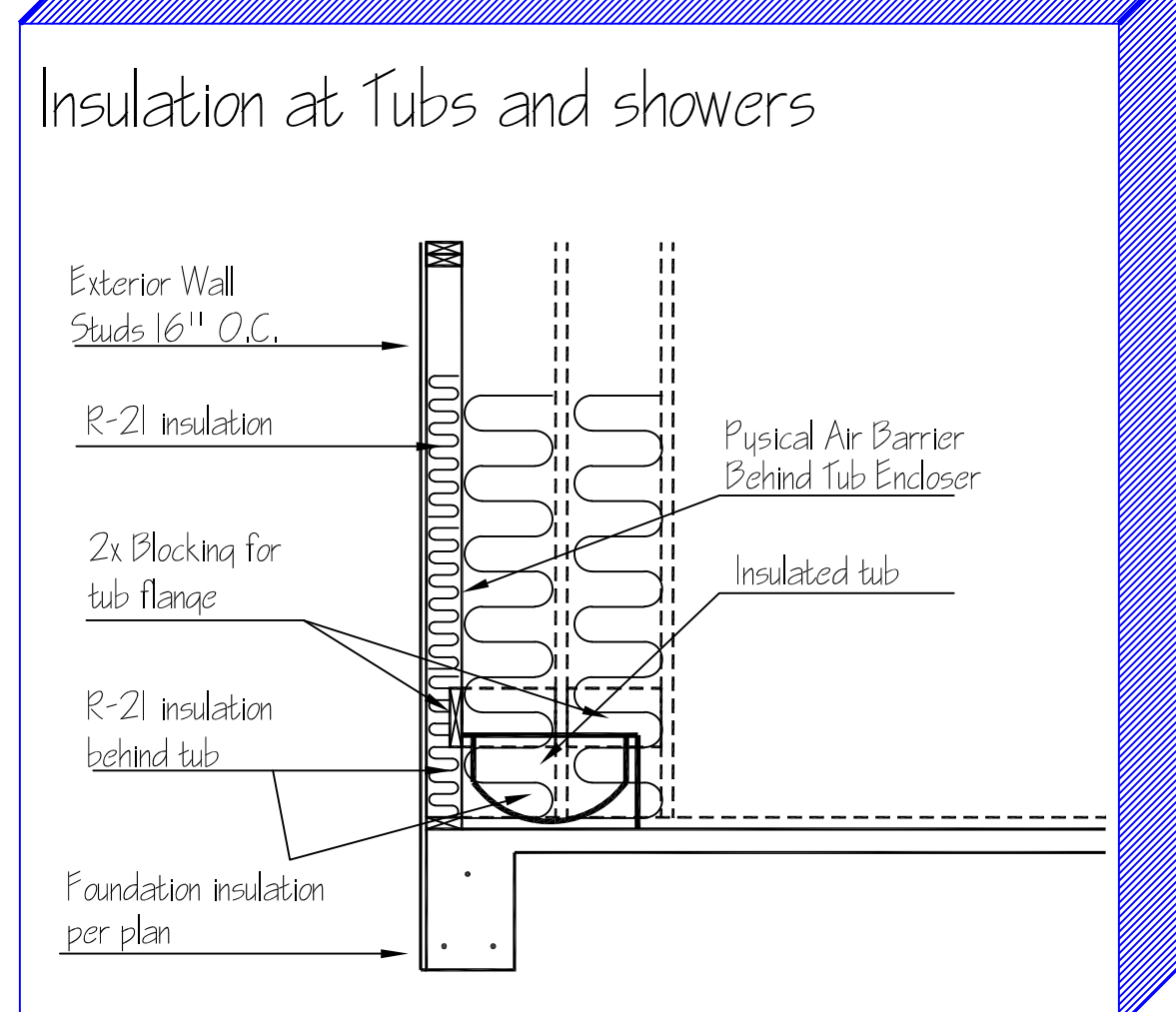
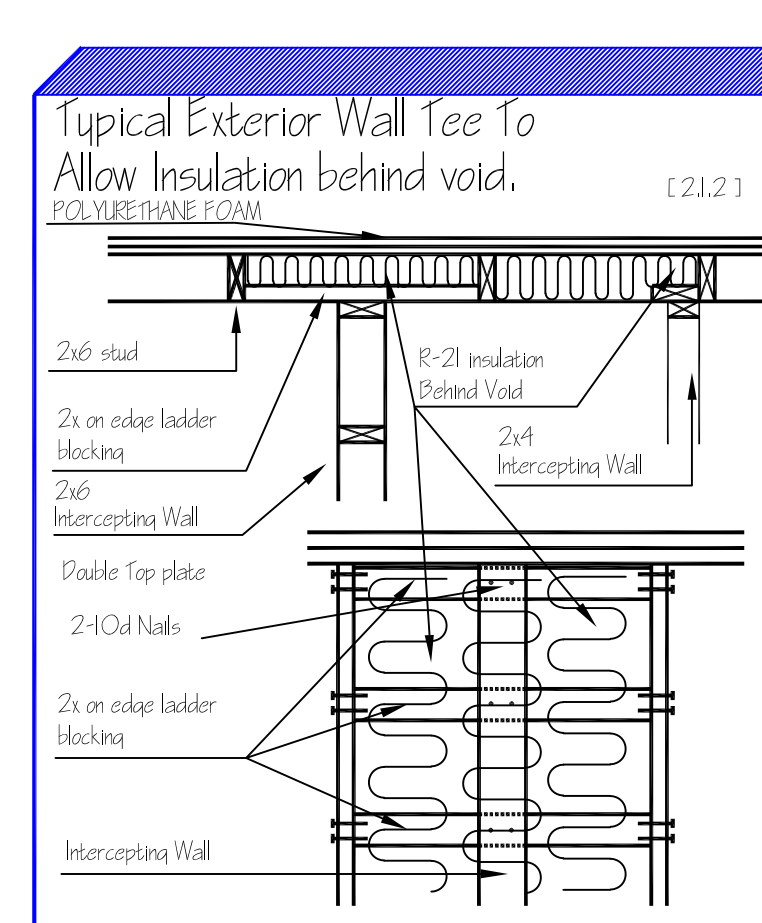
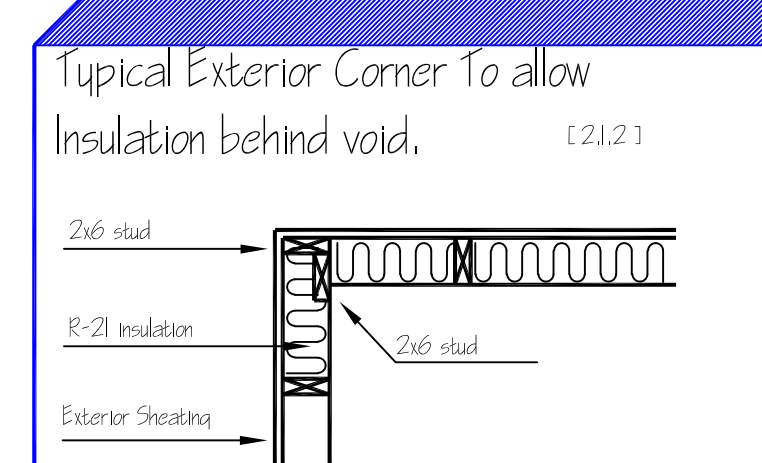

FLASHING:
Provide Flashing per 2021 NMRBC R703.4

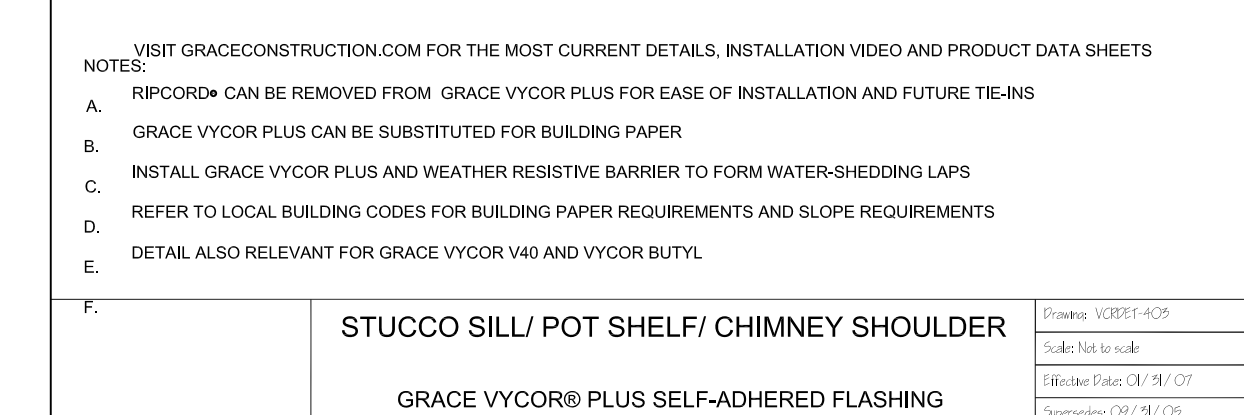
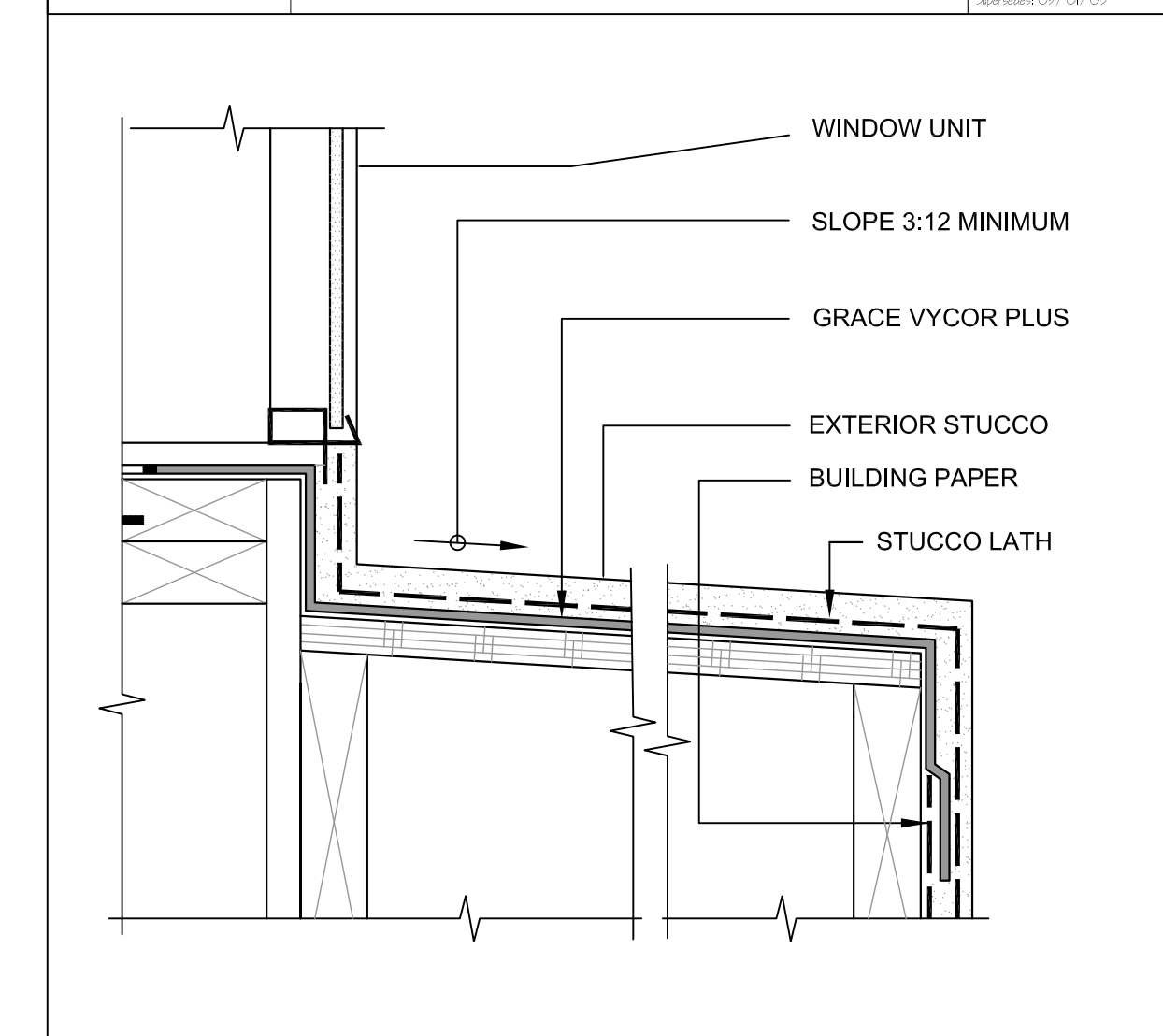
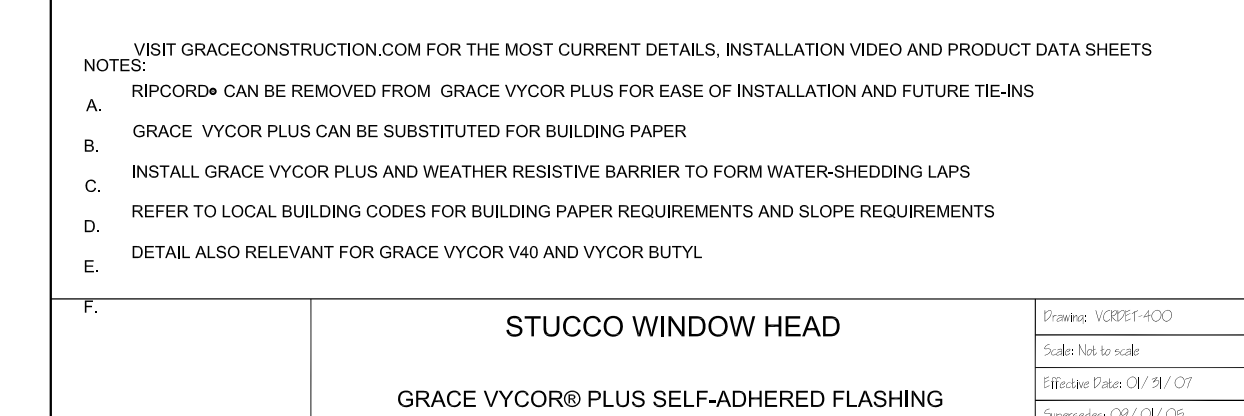
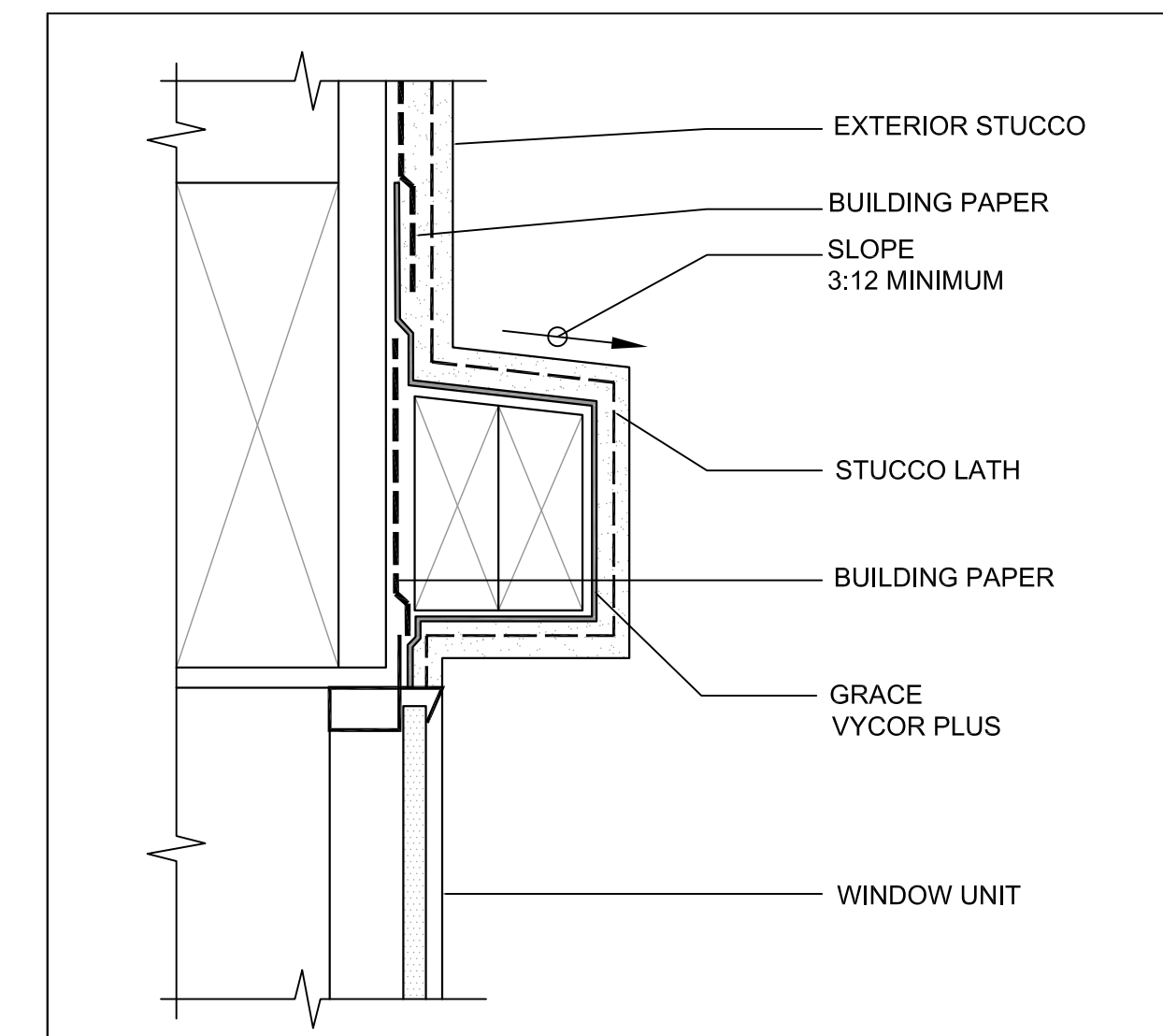

Insulation Details

NTS

LAST REVISION DATE: 2/14/2024

SHEET	CITY OF ALBUQUERQUE
6 OF 6	ABQ ADU Model 650
	FLAT ROOF